

## REQUEST FOR QUOTATION

	<b>BHARAT HEAVY ELECTRICALS LIMITED</b> Electronics Division PB No. 2606, Mysore Road Bangalore - 560026 INDIA	RFQ NUMBER: <b>ANK0000162</b>  RFQ DATE : 24.07.2018	Due Date/Day: 10.08.2018 FRI Time : 13:00 HRS Tender Box : Reception Area Opening Venue: NEW ENGG. BLDG
MMI:PU:RF:003	(address for communication) :		(for all correspondence)
		Purchase Executive : Ankita Reja Phone : 26989637 Fax : E-mail: ankitareja@bheledn.co.in	

1. Please drop your offer before due date & time in the tender box named "Friday" kept at the reception of BHEL-ESD, Electronic city phase-1, Bangalore.

2. Offers by e-mail are also accepted. Offers by email should contain separate files for PQC, techno-commercial and price bids. The offers by Email shall be sent to "defnesdmm@bhel.in" specified in the RFQ with the subject ANK0000162\_10.08.2018\_Friday\_Li-Ion\_Winding Machine.

3. List of document enclosed along with RFQ:

- RFQ-ANK00000162-Special Terms and Conditions
- Purchase specification - PS-251-607 (Rev 01)DT. 23.07.2018
- Doc. Ref: CAPITAL-2017 (SCHEME)for general terms & conditions
- ANK0000162 - Price bid format
- Annexure-I (Company performance)
- Integrity pact

SI No.	Description	Qty	Unit	Delivery qty	Delivery Date
1	KA9018209255 Winding Machine * HSN/SAC : 9032  Winding Machine as per spec: PS-251-607	1	NO	1	14.11.2018

Total Number of Items - 1

-----

- 
- 

**TWO PART BID - SUBMIT TECHNICAL AND PRICE BID IN SEPARATE SEALED COVERS**

<p>NOTES :</p> <ol style="list-style-type: none"> <li>This RFQ is Governed by :                     <ol style="list-style-type: none"> <li>INSTRUCTIONS TO BIDDERS/SELLERS(Doc No :BHEL:EDN:ITB-SHOP) available at <b>www.bheledn.com (RFQ-PO Terms &amp; Conditions)</b></li> <li>GENERAL CONDITIONS OF CONTRACT FOR PURCHASE(Doc no :BHEL:EDN:GCC-SHOP) available at <b>www.bheledn.com (RFQ-PO Terms &amp; Conditions)</b></li> <li>Any other specific Terms and Conditions mentioned.</li> </ol> </li> <li>Bidders / Representatives who would like to be present during opening of offers are required to furnish authorization letter for the same .</li> </ol> <p>* The HSN/SAC no mentioned against the line items in the RFQ are indicative only.</p>	For and On behalf of BHEL.   Ankita Reja Contrl Eqment - ESD  1 OF 1
--	--

**RFQ No. ANK0000162 - SPECIAL TERMS AND CONDITIONS**

**THIS "SPECIAL CONDITIONS OF CONTRACT" WILL FORM AN INTEGRAL PART OF THE CONTRACT AS AND WHEN THE RFQ CULMINATES INTO A PURCHASE ORDER / CONTRACT.**

1. SEPARATE OFFER IN ENGLISH LANGUAGE ADDRESSED TO THE PURCHASE EXECUTIVE SHALL BE MADE FOR THIS RFQ IN TWO PARTS. BID SHALL BE SUBMITTED AS PER THE INSTRUCTION GIVEN IN DOC. REF. CAPITAL -2017(SCHEME)

NOTE:

a) PRE-QUALIFICATION CRITERIA ARE MANDATORY REQUIREMENTS AND WILL BE CARRIED OUT BASED ON THE DETAILS FURNISHED BY THE VENDOR/FEEDBACK FROM THEIR CUSTOMERS AND INSPECTION OF THE COMPANY/PRODUCTS, IF REQUIRED BY BHEL AT ITS SOLE DISCRETION.

b) THE PRE-QUALIFICATION CRITERIA ARE MANDATORY REQUIREMENTS.

2. VENDOR HAS TO SEAL & SIGN EACH AND EVERY PAGE/DOCUMENT OF THE RFQ.
3. VENDOR IS ADVISED TO GO THROUGH THE GENERAL TERMS AND CONDITIONS, DOCUMENT CAPITAL-2017 SCHEME ENCLOSED WITH THIS RFQ. VENDOR HAS TO CONFORM TO ALL THE CLAUSES LISTED IN THE COMMERCIAL TERMS (ANNEXURE B FOR INDIGENOUS VENDORS AND ANNEXURE A FOR FOREIGN VENDORS) OF CAPITAL-2017 SCHEME. DEVIATIONS, IF ANY, TO BE HIGHLIGHTED AND BROUGHT OUT CLEARLY IN THE TECHNO-COMMERCIAL BID.
4. EARNEST MONEY DEPOSIT (EMD) OF RS. 2,00,000.00 (TWO LAKHS ONLY) IS MANDATORY AND TO BE SUBMITTED ALONGWITH THE TECHNO-COMMERCIAL BID. PLEASE REFER CLAUSE NO. 10 OF PAGE NO. 03 OF CAPITAL 2017 SCHEME. EMD SHALL BE SENT EITHER BY PAY ORDER /DEMAND DRAFT IN FAVOUR OF M/S BHARAT HEAVY ELECTRICALS LTD, ELECTRONICS DIVISION, BANGALORE - 560026 . IN CASE OF FOREIGN BIDDER E-PAYMENT MAY ALSO BE MADE AS EMD , DETAILS SHALL BE OBTAINED FROM PURCHASE EXECUTIVE MS. ANKITA REJA / MS. V M KALYANI /AT EMAIL: ankitareja@bhel.in / manikya.kalyani@bhel.in AND CONTACT NO: +91-80-25146134 / 167. **OFFERS WITHOUT VALID EMD WILL BE REJECTED.**
5. **QUOTATIONS SHOULD BE SENT TO:  
BHEL-ESD, PLOT NO. #98, ELECTRONIC CITY PHASE 1, HOSUR ROAD, BANGALORE-560100.**
6. WARRANTY: 30 MONTHS FROM THE DATE OF SUPPLY OR 24 MONTHS FROM THE DATE OF SUCCESSFUL COMMISSIONING WHICHEVER IS EARLIER.
7. DELIVERY PERIOD SHALL BE 20 WEEKS FROM THE DATE OF PURCHASE ORDER.
8. ADVANCE PAYMENT: BIDS SEEKING ADVANCE PAYMENT SHALL BE LIABLE FOR REJECTION.
9. PAYMENT TERMS AGAINST PROFORMA INVOICE ARE NOT ACCEPTABLE. HENCE, THE RELEVANT POINT IN A(ii) PAGE NO. 12 OF CAPITAL 2017 ARE NOT APPLICABLE FOR THIS RFQ.
10. DELIVERY TERMS-FOB INTERNATIONAL SEAPORT(IF APPLICABLE ) MAY PLEASE BE CONSIDERED AS CIF ICD BANGALORE.
11. TERMS MENTIONED IN THIS RFQ WILL BE TREATED AS FINAL IN CASE OF ANY AMBIGUITY.
12. PLEASE FURNISH SPECIFIC DETAILS OF YOUR COMPANY PERFORMANCE AS PER ANNEXURE-I (A. CAPACITY DETAILS; B. PERFORMANCE OF SUPPLIES TO BHEL).
13. CONTRACT EXECUTION BANK GUARANTEE TO BE SUBMITTED (PLEASE REFER CLAUSE 19 ON PAGE NO. 7 OF CAPITAL 2017).
14. INSTALLATION AND COMMISSIONING CHARGES SHOULD BE QUOTED AS 10% OF VALUE OF THE EQUIPMENT.

15. PLEASE FIND ENCLOSED A COPY OF INTEGRITY PACT AGREEMENT. THE SAME HAS TO BE FILLED AND SIGNED BY AUTHORIZED SIGNATORY WHO SIGNS THE BID AND TO BE SUBMITTED ALONG WITH TECHNO-COMMERCIAL (PART-1 BID) OFFER. ONLY THOSE VENDOR/BIDDERS WHO HAVE ENTERED INTO SUCH AN IP WITH BHEL WOULD BE COMPETENT TO PARTICIPATE IN THE BIDDING. IN OTHER WORDS, ENTERING INTO THIS PACT WOULD BE PRELIMINARY QUALIFICATION.

16. PLEASE QUOTE PRICE BID AS PER PRICE BID FORMAT ENCLOSED.

17. PLEASE SUBMIT UNPRICED BID (COPY OF PRICE BID AFTER HIDING PRICE) ALONG WITH TECHNICAL BID.

18. ANY DEVIATIONS FROM OR ADDITIONS TO THE "GENERAL CONDITIONS OF CONTRACT" OR "SPECIAL TERMS AND CONDITIONS" REQUIRE BHEL'S EXPRESS WRITTEN CONSENT. THE GENERAL TERMS OF BUSINESS OR SALE OF THE BIDDER SHALL NOT APPLY TO THIS TENDER.

19. NON ACCEPTANCE / DEVIATIONS IF ANY TO THE TERMS AND CONDITIONS OF THE RFQ SHALL BE CLEARLY AND EXPLICITLY MENTIONED IN THE OFFER, OTHERWISE IT WILL BE TREATED THAT ALL THE TERMS AND CONDITIONS OF THE RFQ ARE ACCEPTED BY THE BIDDER IN TOTAL.

20. ARBITRATION & CONCILIATION CLAUSE:

THE PARTIES SHALL ATTEMPT TO SETTLE ANY DISPUTES OR DIFFERENCE ARISING OUT OF THE FORMATION, BREACH, TERMINATION, VALIDITY OR EXECUTION OF THE CONTRACT; OR, THE RESPECTIVE RIGHTS AND LIABILITIES OF THE PARTIES; OR, IN RELATION TO INTERPRETATION OF ANY PROVISION OF THE CONTRACT; OR, IN ANY MANNER TOUCHING UPON THE CONTRACT, OR IN CONNECTION WITH THIS CONTRACT THROUGH FRIENDLY DISCUSSIONS. IN CASE NO AMICABLE SETTLEMENT CAN BE REACHED BETWEEN THE PARTIES THROUGH SUCH DISCUSSIONS, IN RESPECT OF ANY DISPUTE; THEN, EITHER PARTY MAY, BY A NOTICE IN WRITING TO THE OTHER PARTY REFER SUCH DISPUTE OR DIFFERENCE TO THE SOLE ARBITRATION OF AN ARBITRATOR APPOINTED BY HEAD OF THE BHEL -EDN. SUCH SOLE ARBITRATOR APPOINTED, SHALL CONDUCT THE ARBITRATION IN ENGLISH LANGUAGE.

THE ARBITRATOR SHALL PASS A REASONED AWARD AND THE AWARD OF THE ARBITRATION SHALL BE FINAL AND BINDING UPON THE PARTIES.

SUBJECT AS AFORESAID, THE PROVISIONS OF ARBITRATION AND CONCILIATION ACT 1996 (INDIA) OR STATUTORY MODIFICATIONS OR RE-ENACTMENTS THEREOF AND THE RULES MADE THEREUNDER AND FOR THE TIME BEING IN FORCE SHALL APPLY TO THE ARBITRATION PROCEEDINGS UNDER THIS CLAUSE. THE SEAT OF ARBITRATION SHALL BE BANGALORE.

THE COST OF ARBITRATION SHALL BE BORNE AS DECIDED BY THE ARBITRATOR UPON HIM ENTERING THE REFERENCE.

SUBJECT TO THE ARBITRATION CLAUSE AS ABOVE, THE COURTS AT BANGALORE ALONE SHALL HAVE EXCLUSIVE JURISDICTION OVER ANY MATTER ARISING OUT OF OR IN CONNECTION WITH THIS CONTRACT.

NOTWITHSTANDING THE EXISTENCE OR ANY DISPUTE OR DIFFERENCES AND/OR REFERENCE FOR THE ARBITRATION, THE PARTIES SHALL PROCEED WITH AND CONTINUE WITHOUT HINDRANCE THE PERFORMANCE OF ITS OBLIGATIONS UNDER THIS CONTRACT WITH DUE DILIGENCE AND EFFICIENCY IN A PROFESSIONAL MANNER EXCEPT WHERE THE CONTRACT HAS BEEN TERMINATED BY EITHER PARTY IN TERMS OF THIS CONTRACT.



**PURCHASE SPECIFICATION  
FOR LI-ION ELECTRODE WINDING  
MACHINES**

PS-251-607



REV. 01

**EQUIPMENT: LI-ION ELECTRODE WINDING MACHINES**

- 1. AUTOMATIC WINDING MACHINE FOR PRISMATIC CELLS**
  - 2. SEMI-AUTOMATIC WINDING MACHINE FOR CYLINDRICAL CELLS**
- (The vendor may quote for either of the machine or both the machines. The technical scrutiny shall be done separately for two machines and separate orders shall be placed based on individual lowest technically acceptable bid).

**REVISION HISTORY SHEET**

REV NO	DATE	NATURE OF CHANGE	REASON	PREPARED BY	APPROVED BY
00	30-5-18	New Issue	-	Ripandeep Singh	LN Satapathy
01	23-07-18	Specs for two separate machines	No quote received for combined machine	Ripandeep Singh	LN Satapathy

REVISION : 01	APPROVED  LN Satapathy		
	PREPARED  Ripandeep Singh	ISSUED ENGG	DATE 23-07-2018

	<b>PURCHASE SPECIFICATION FOR LI-ION ELECTRODE WINDING MACHINES</b>	PS-251-607
		REV. 01

**SCOPE: Design, Supply, Installation & commissioning of Li-Ion Electrode winding machines at BHEL for Lithium Ion cell manufacturing facility**

**Pre-Qualification Criteria (PQC)**

The supplier shall necessarily meet the following conditions.

<b>Sl. No</b>	<b>Particulars</b>	<b>Supplier's confirmation (Yes/No)</b>
<b>1</b>	The vendor shall be an Original Equipment Manufacturer (OEM) or their authorized dealers/representative. A latest valid authorization letter from OEM giving full contact details (add., email & phone no) shall be furnished along with offer (by dealer/ representative).	
<b>2</b>	Offer shall be for new equipment and not for any refurbished or used equipment. All the parts used in the equipment shall be new and not used / refurbished ones. A declaration to that effect to be furnished.	
<b>3</b>	Supplier shall supply, install and commission the equipment as per BHEL Specification.	
<b>4</b>	Vendor shall have an experience of supplying similar <b>Winding Machines</b> to at least 3 customers (details of customers to be provided) as on date of tender opening. Certificate of satisfactory performance/ User acceptance certificate/ Successful commissioning certificate/ PO shall be furnished from at least one such customer. For vendors outside India, out of 3 customers reference, at least 1 shall be from a country other than the country of origin.	
<b>5</b>	Supplier shall agree for Annual Maintenance Contract (AMC) for a period of three (03) years after the expiration of warranty period. The vendor or their authorized service representative should be equipped to provide prompt after sales service, spares & support for the offered equipment at BHEL ESD, Bangalore, India.	

**Note:** 1-The Pre-Qualification Criteria are mandatory requirements and the technical bid will be considered only if all the above PQC are met.

2-All Supporting documents related to PQC shall be enclosed in techno-commercial offer.



**PURCHASE SPECIFICATION  
FOR LI-ION ELECTRODE WINDING  
MACHINES**

PS-251-607

REV. 01

**SCOPE**

This document establishes the specifications for the design, supply and commissioning of Li-Ion Electrode winding machines as per details below. It includes the hardware specifications & requirements, deliverables, documents and other general conditions. The machines shall be commissioned at 1st floor, Old Production Block, Electronics Systems Division, BHEL, Electronic City, Bangalore.

**Application**

- Both positive and negative electrode along with separators are to be wound to make Jelly rolls/ Electrode stack in prismatic/ cylindrical configuration for lithium ion battery applications.
- Material and dimensions of the electrode for prismatic & cylindrical stacks to be wound are given in **Table-1 & Table-2** respectively.
- Electrodes and separator will be provided in spool form. Spool material is SS/PP/Al.
- Configurations of the stacks to be wound are given in the **Annexure-1**.
- **Prismatic stack winding machine shall be fully automatic winding machine as per below specs.**
- **Cylindrical stack winding machine shall be semi-automatic machine as per below specs.**
- Interchangeability between positive and negative electrode line shall be possible.

Attributes	Positive Electrode	Negative Electrode	Separator	Tape
Thickness	70 to 200 $\mu\text{m}$	70 to 200 $\mu\text{m}$	15 to 25 $\mu\text{m}$	25- 30 $\mu\text{m}$
Substrate material	Aluminium	Copper	PP/PE/PP or PE	Acrylic adhesive PP or Polyimide
Substrate thickness	20 $\mu\text{m} \pm 2$	10 $\mu\text{m} \pm 1$		
Width	60 to 190 mm $\pm 0.5$	60 to 190 mm $\pm 0.5$	60 to 185 mm $\pm 0.5$	25 mm

**Table 1: Details of electrode and separator used for winding into a stack (for prismatic stack).**



**PURCHASE SPECIFICATION  
FOR LI-ION ELECTRODE WINDING  
MACHINES**

**PS-251-607**

**REV. 01**

<b>Attributes</b>	<b>Positive Electrode</b>	<b>Negative Electrode</b>	<b>Separator</b>
<b>Thickness</b>	70 to 200 $\mu\text{m}$	70 to 200 $\mu\text{m}$	15 to 25 $\mu\text{m}$
<b>Substrate material</b>	Aluminium	Copper	PP/PE/PP or PE
<b>Substrate thickness</b>	20 $\mu\text{m} \pm 2$	10 $\mu\text{m} \pm 1$	
<b>Width</b>	60.8mm (details in stack drg.)	60.8mm (details in stack drg.)	60.8mm (details in stack drg.)

**Table 2: Details of electrode and separator used for winding into a stack (for cylindrical stack).**



**PURCHASE SPECIFICATION  
FOR LI-ION ELECTRODE WINDING  
MACHINES**

PS-251-607

REV. 01

**Detailed Specifications**

Sl No	MATERIAL/PROCESS DISCRIPSON	TECHNICAL SPECIFICATION (Prismatic winding machine)	Supplier's Confirmation (Yes/No)	TECHNICAL SPECIFICATION (Cylindrical winding machine)	Supplier's Confirmation (Yes/No)
<b>WINDING</b>					
1	Type of machine	Automatic winding machine		Semi-automatic winding machine	
2	Type of winding	Prismatic (Elliptic cylindrical) as per <b>Table-3</b> (dimensions of stacks) with option of with core or coreless.		Cylindrical as per <b>Table-4</b> (dimensions of stacks)	
3	Winding Accuracy	Alignment accuracy of $\pm 0.5$ mm or better inside the stack for all configurations.		Alignment accuracy of $\pm 0.5$ mm or better inside the stack.	
4	Winding speed	<ul style="list-style-type: none"> <li>Speed of winding shall be at least 2m per min.</li> <li>Winding head shall be servo motor driven.</li> <li>Adjustable winding speed.</li> <li>Winding speed compensation control shall be provided for elliptic cells.</li> <li>Dynamic Tension control shall be provided.</li> </ul>		<ul style="list-style-type: none"> <li>Speed of winding shall be at least 2m per min.</li> <li>Winding head shall be servo motor driven.</li> <li>Adjustable winding speed</li> <li>Provision for control of tension.</li> </ul>	
5	Mandrel Parts	Mandrel parts for making following stacks as per <b>drawings</b> enclosed shall be provided <ul style="list-style-type: none"> <li>Elliptic cylindrical/Prismatic Type-1</li> </ul>		Mandrel parts for making following stacks as per <b>drawings</b> enclosed shall be provided: Cylindrical Type-1	





**PURCHASE SPECIFICATION  
FOR LI-ION ELECTRODE WINDING  
MACHINES**

PS-251-607

REV. 01

		<ul style="list-style-type: none"> <li>• Elliptic cylindrical/Prismatic Type-2 &amp;3</li> </ul>			
6	Tape	<ul style="list-style-type: none"> <li>• Provision to load Polyimide tape roll.</li> <li>• Automatic application of Tape on the wound stack after completion of winding.</li> </ul>		Provision for putting tape automatically/ manually.	
7	Removal of stack	<ul style="list-style-type: none"> <li>• Mechanism to shrink the mandrel for easy removal of stack.</li> <li>• Mechanism to automatically remove the stack after completion of winding and application of tape.</li> <li>• After removing the stack, it shall be un-loaded into a bin/ conveyer.</li> <li>• Removal of stack shall be done without disturbing the alignment of separator &amp; electrode rolls.</li> </ul>		<ul style="list-style-type: none"> <li>• Mechanism to shrink the mandrel for easy removal of stack.</li> <li>• Automatic/ Manual removal of wound stack.</li> <li>• Removal of stack shall be done without disturbing the alignment of separator &amp; electrode rolls.</li> </ul>	
8	Tension control	<ul style="list-style-type: none"> <li>• Mechanism for dynamic tension control shall be provided.</li> <li>• Tension shall be independent of reel diameter.</li> </ul>		Mechanism for tension control shall be provided.	



**PURCHASE SPECIFICATION  
FOR LI-ION ELECTRODE WINDING  
MACHINES**

PS-251-607

REV. 01

9	Web alignment	<ul style="list-style-type: none"> <li>Automatic web and reel alignment system shall be provided to guide the electrodes and separators during winding.</li> <li>Continuous web alignment close to winding head.</li> </ul>		<ul style="list-style-type: none"> <li>Web and reel alignment system shall be provided to guide the electrodes and separators during winding.</li> <li>Web alignment close to winding head.</li> <li>Provision for control of winding alignment.</li> </ul>	
<b>ELECTRODE FEED</b>					
10	Electrode feed	<ul style="list-style-type: none"> <li>Automatic smooth insertion system shall be provided for both electrodes</li> <li>Length of initial and final offset of electrodes shall be precisely programmable.</li> <li>Encoder to be provided to accurately measure the length of electrodes being wound</li> </ul>		<ul style="list-style-type: none"> <li>Smooth insertion system shall be provided for both electrodes</li> <li>Length of initial and final offset of electrodes shall be adjustable.</li> <li>Provision to measure the length of electrodes being wound.</li> </ul>	
11	Separator feed	Separator has to be always held by grippers to prevent any misalignment or wrinkles during initial insertion.		<ul style="list-style-type: none"> <li>Separator has to be always held by grippers to prevent any misalignment or wrinkles during initial insertion.</li> </ul>	
12	Cutting system	<ul style="list-style-type: none"> <li>Mechanism to cut the electrodes and separator after defined length.</li> <li>Alignment or tension shall not get</li> </ul>		Cutting system for separator cutting without wrinkles & without disturbing the stack shall be provided.	



**PURCHASE SPECIFICATION  
FOR LI-ION ELECTRODE WINDING  
MACHINES**

PS-251-607

REV. 01

		altered during cutting operation			
<b>UNWINDING HEAD</b>					
13	Electrode roll core diameter	76mm (3 inch)		76mm (3 inch) (for separator).	
14	Electrode roll diameter	<ul style="list-style-type: none"> <li>• 250mm or more (vendor to specify)</li> <li>• Vendor to specify the minimum electrode roll diameter explicitly.</li> </ul>		<ul style="list-style-type: none"> <li>• 200mm or more for separator (vendor to specify)</li> <li>• Vendor to specify the minimum electrode roll diameter explicitly.</li> </ul>	
15	Locking of Electrode roll	Pneumatic chuck shall be provided to hold the electrode & separator rolls.		Pneumatic chuck shall be provided to hold the separator rolls.	
16	Spool alignment	Mechanism for automatic alignment of spools.		Mechanism for alignment of spools.	
17	Unwinding	The unwinding shall be through a motor, synchronized with stack winding speed.		The unwinding shall be through a motor, synchronized with stack winding speed.	

**Table 3: Dimensions of prismatic stacks to be wound (refer to stack drawing for details)**

Configuration	Dimensions of the stack		
	Width (mm)	Length (mm)	Height (mm)
Prismatic			
Type-1	16	60	62
Type-2	45	124	107
Type-3	45	125	192



**PURCHASE SPECIFICATION  
FOR LI-ION ELECTRODE WINDING  
MACHINES**

PS-251-607

REV. 01

**Table 4: Dimensions of cylindrical stack to be wound (refer to stack drawing for details)**

Cylindrical	Dimensions	
Type-1	Dia: 17.1mm	Height: 60.8mm

**GENERAL SPECIFICATIONS (common for both prismatic & cylindrical winding machines):**

**Removal of electrode particles**

- Physical separation shall be provided for the electrode/separator path in order to avoid contamination.

**Enclosure**

- Suitable enclosure shall be provided for the winding machine.
- Front portion shall be transparent for viewing.

**Control System**

The PLC shall be from reputed vendors like Allen Bradley, Siemens etc. A coloured HMI touch screen (at least 12 inches) shall be supplied to set the parameters and to monitor the process.

Following parameters shall be programmable in the control system.

Sl.No	Programmable Parameters (prismatic winding)	Programmable/ Settable Parameters (cylindrical winding)
1	Initial separator winding turns	Initial separator winding turns
2	Initial electrode offset length between anode and cathode	Initial electrode offset length between anode and cathode
3	Winding turns	Winding turns
4	Electrode length	Electrode length
5	Final electrode offset length between anode and cathode	Final electrode offset length between anode and cathode
6	Final separator winding turn/length	Final separator winding turn/length
7	Winding speed	Winding speed
8	Winding acceleration/deceleration	-
9	Web tension control settable for each electrode and each separator	Web tension control settable for each electrode and each separator
10	Mandrel dimensions for prismatic windings.	Mandrel dimensions for cylindrical winding
11	Material thickness	Material thickness

- Communication interface for connecting to PC (like USB, Ethernet, Serial interface) shall be provided to capture all winding data on PC.
- On-line trouble shooting support feature for Remote diagnostics through internet.



**PURCHASE SPECIFICATION  
FOR LI-ION ELECTRODE WINDING  
MACHINES**

PS-251-607

REV. 01

**Input Power/ Compressed air**

- AC 230 V $\pm$  10%, Single Phase / 415 V  $\pm$  10%, 3 Phase 50 Hz supply.
- BHEL shall supply compressed air at 6 Bar pressure.

(The equipment shall withstand power supply tolerances as indicated above).

**Power Failure Conditions**

- Vendor shall indicate the steps to be followed to resume winding after a power failure.
- If any part needs to be on UPS, vendor has to clearly specify.

**Safety**

- All necessary safety enclosures, safety interlocks shall be provided with alarm for fail-safe operations of the machine and the operator (vendor to specify explicitly).
- Audio, visual alarms for
  - Low/high Tension
  - Low/High Pneumatic air pressure
  - Mandrel position error
  - Machine home position error etc.
  - Electrode break
  - Emergency switch actuation
  - Parameters crossing the set values

**PRE-DISPATCH INSPECTION:**

BHEL shall carry out Pre-dispatch inspection of equipment at Vendor's work.

Vendor shall demonstrate proper functioning of equipment and also demonstrate equipment meeting all the specifications.

Vendor shall give initial training for its operation, programming and maintenance. BHEL engineers shall carry out winding trials for evaluating the performance of the machine. In each configuration, few numbers of stacks of each type will be wound and inspected for dimensions and overall alignment. Stacks will be unwound and verified for

- Proper overlap between electrodes and separators.
- No discontinuity of electrodes/separator
- No cracking of initial layers
- No peeling of active material from the substrate



**PURCHASE SPECIFICATION  
FOR LI-ION ELECTRODE WINDING  
MACHINES**

PS-251-607

REV. 01

- Length of electrodes wound with respect to the set values.
- Initial and final offset between electrodes

After satisfactory PDI, BHEL shall give a clearance for dispatch of system.

Vendor has to inform at least 1 month in advance to BHEL for PDI, so that all necessary arrangements can be made.

**Installation & Commissioning/ Training:**

Vendor has to do installation of Machine at BHEL-ESD, Electronic City Phase 1, Bangalore-560100. Vendor shall depute requisite manpower at BHEL premises to complete the installation of machine. Vendor shall arrange to unload/ movement of equipment in BHEL. After completion of installation, the vendor shall demonstrate the performance of system to BHEL's satisfaction as per the specifications.

Vendor shall arrange to train BHEL's personnel in operation of the Winding Machine for required number of days at BHEL's premises free of cost.

**Warranty & AMC**

The vendor shall provide a warranty of the Winding machine for a period of 24 months from date of successful commissioning or 30 months from date of delivery at BHEL ESD whichever is earlier. The warranty shall cover all the spare and wear parts for the entire warranty period. All the preventive maintenance tasks defined in the AMC shall be performed during the complete warranty period as well without any extra payment.

Vendor shall quote separately with this tender for AMC (Annual maintenance contract) for a period of at least 3 years after the expiry of warranty. All the preventive maintenance tasks defined in the AMC shall be performed during the complete warranty period as well without any extra payment. All the maintenance checks and activities to be performed at quarterly and annual basis as per the 'Maintenance Schedule' provided for each equipment shall be completed by the service engineer during the visit to BHEL in assistance with BHEL personnel. Vendor shall minimize the equipment breakdown time by promptly deputing service engineer in case of a breakdown.

The AMC prices shall also be considered during evaluation of vendor. The ordering of AMC shall be at the discretion of BHEL. The quote shall also contain list and price of spares valid for 3 years post-warranty (concurrent with AMC period).



**PURCHASE SPECIFICATION  
FOR LI-ION ELECTRODE WINDING  
MACHINES**

PS-251-607

REV. 01

**General**

- a. **The Vendor shall enclose a point to point compliance / deviation matrix with respect to each of the specifications as mentioned above along with the offer without which the offer will not be considered.**
- b. The technical scrutiny shall be done **separately for two machines** and separate orders shall be placed based on individual lowest technically acceptable bid.
- c. Vendor to ensure suitable packing of the equipment.
- d. The Vendor shall clearly indicate the peak and operating power rating (kW) and compressed air requirement (CFM) of the equipment.
- e. Vendor shall provide the dimensions, weight, electrical requirements and civil requirements along with offer.
- f. Vendor shall provide general arrangement drawing of the equipment along with the offer.
- g. **Vendor shall mention the prices of two machines, AMC of two machines, List of spares for two machines separately.**



**PURCHASE SPECIFICATION  
FOR LI-ION ELECTRODE WINDING  
MACHINES**

PS-251-607

REV. 01

**Annexure – 1  
Prismatic Type 1**

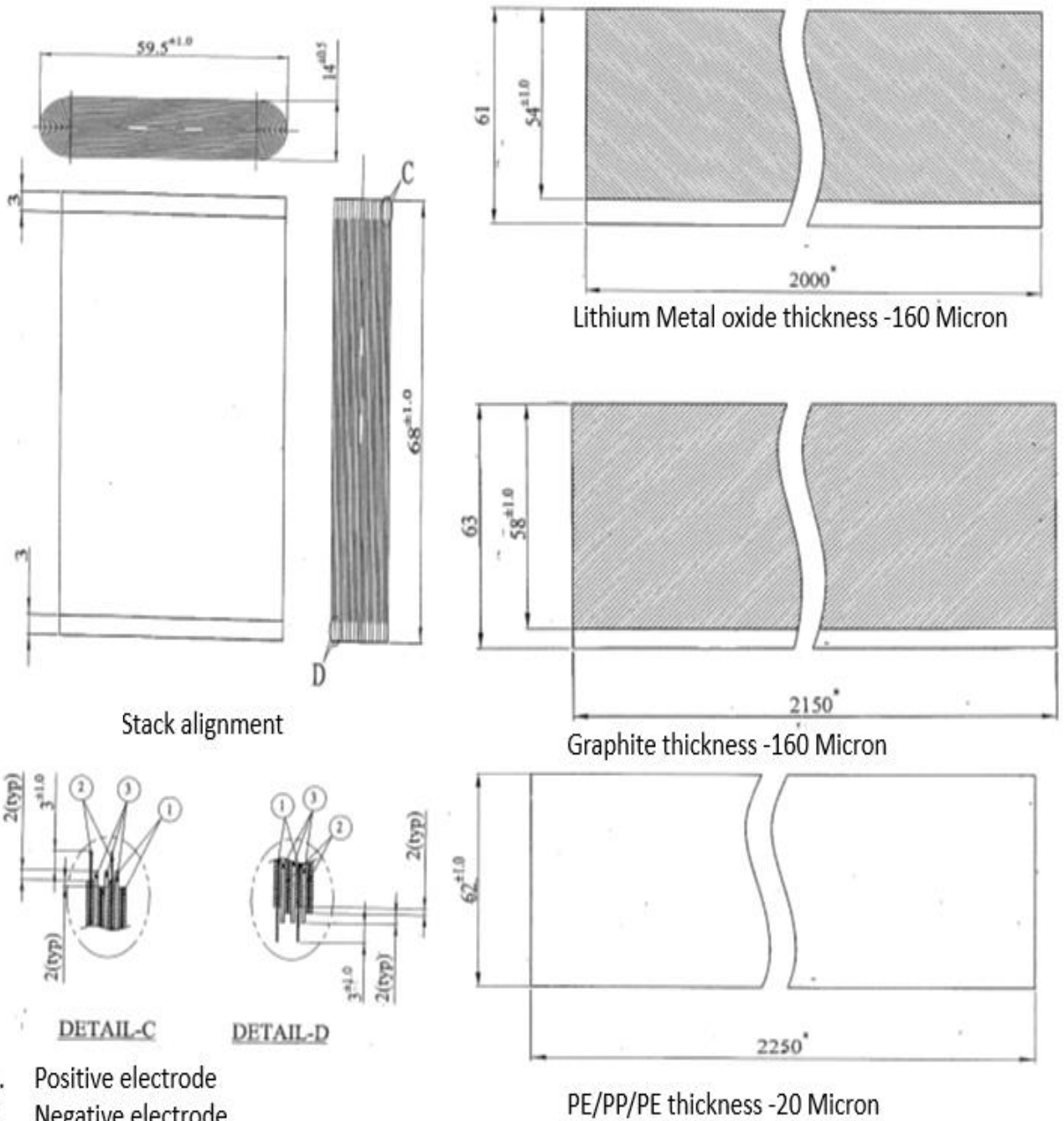

1. Positive electrode
2. Negative electrode
3. Separator





**PURCHASE SPECIFICATION  
FOR LI-ION ELECTRODE WINDING  
MACHINES**

PS-251-607

REV. 01

## Prismatic Type 2

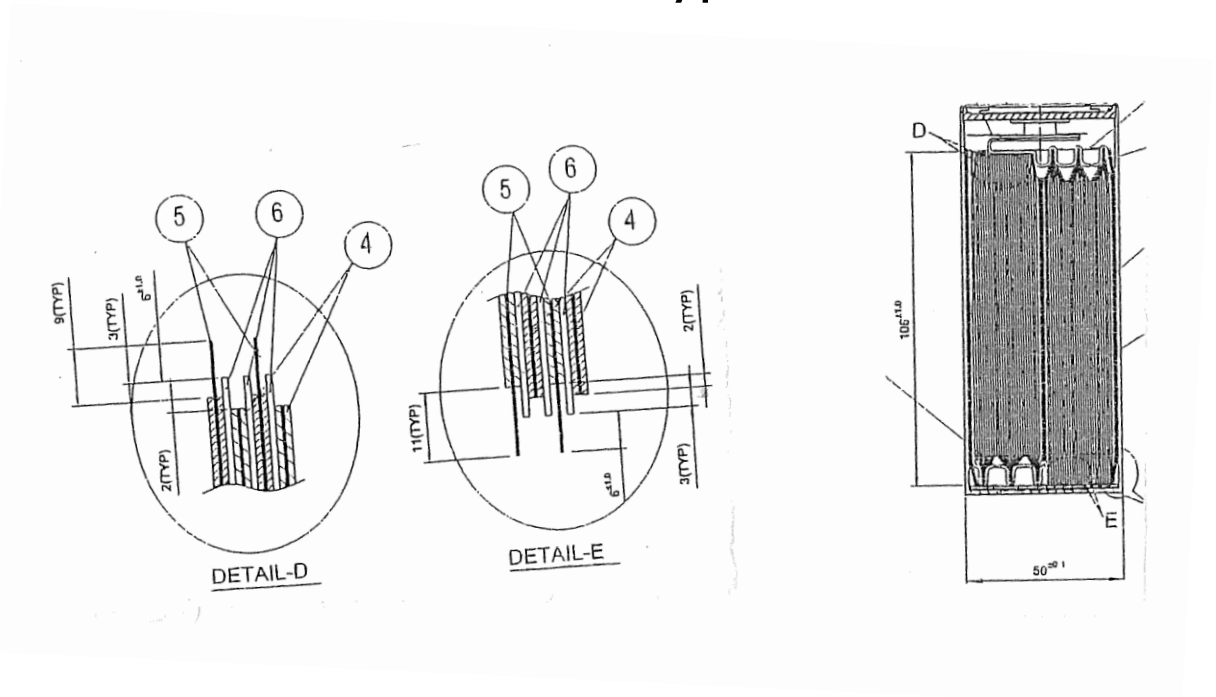

## Stack alignment

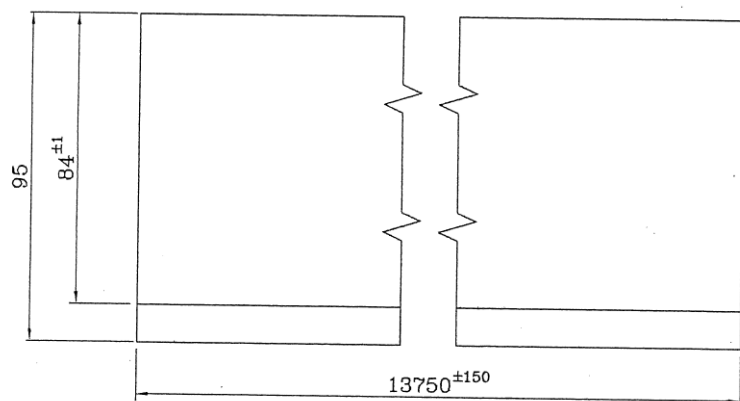

Lithium Metal oxide thickness -160 Micron



**PURCHASE SPECIFICATION  
FOR LI-ION ELECTRODE WINDING  
MACHINES**

**PS-251-607**

**REV. 01**

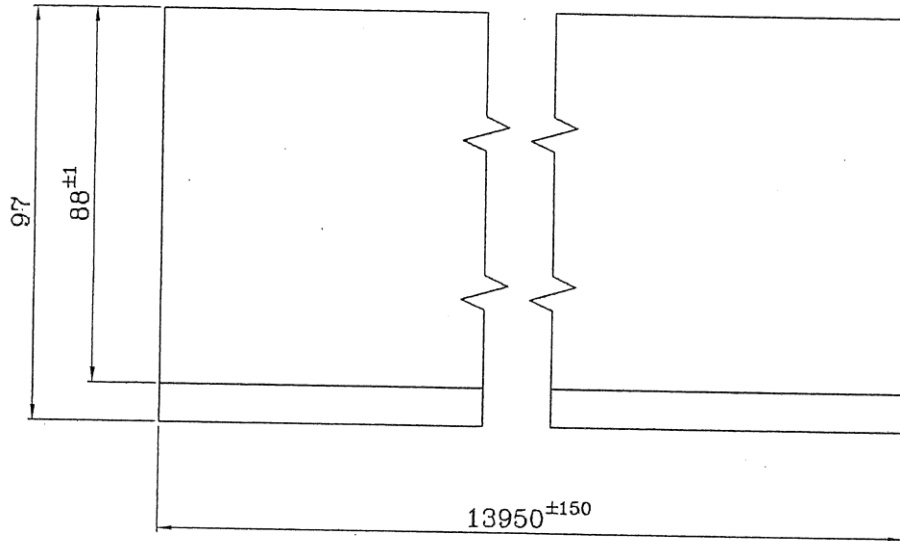

**Graphite thickness -160 Micron**

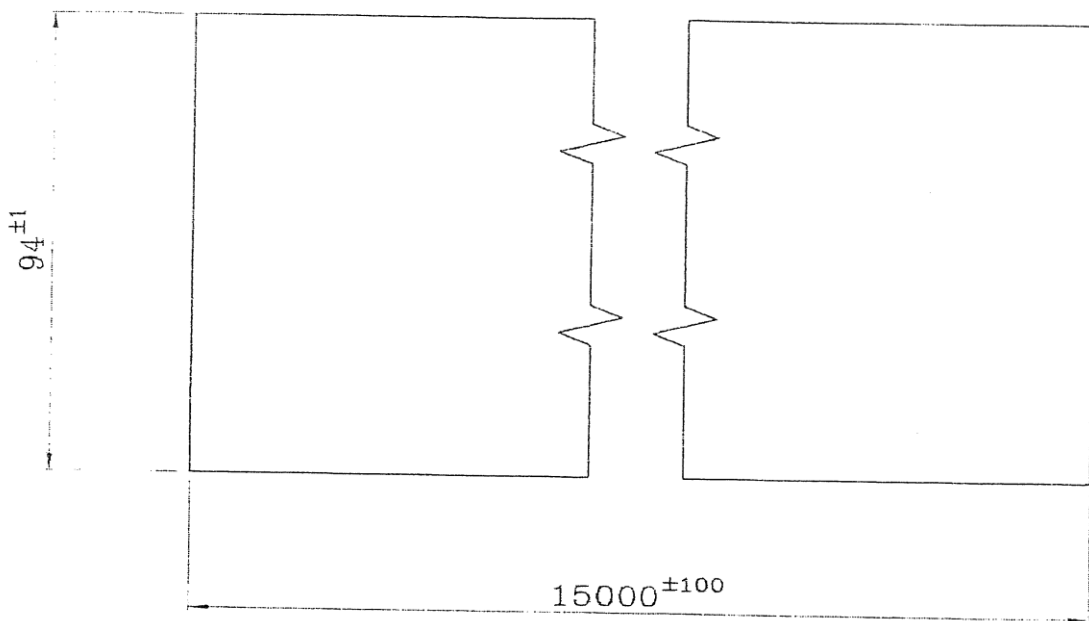

**PP/PE/PP thickness -20 Micron**



**PURCHASE SPECIFICATION  
FOR LI-ION ELECTRODE WINDING  
MACHINES**

**PS-251-607**

**REV. 01**

**Prismatic Type 3**

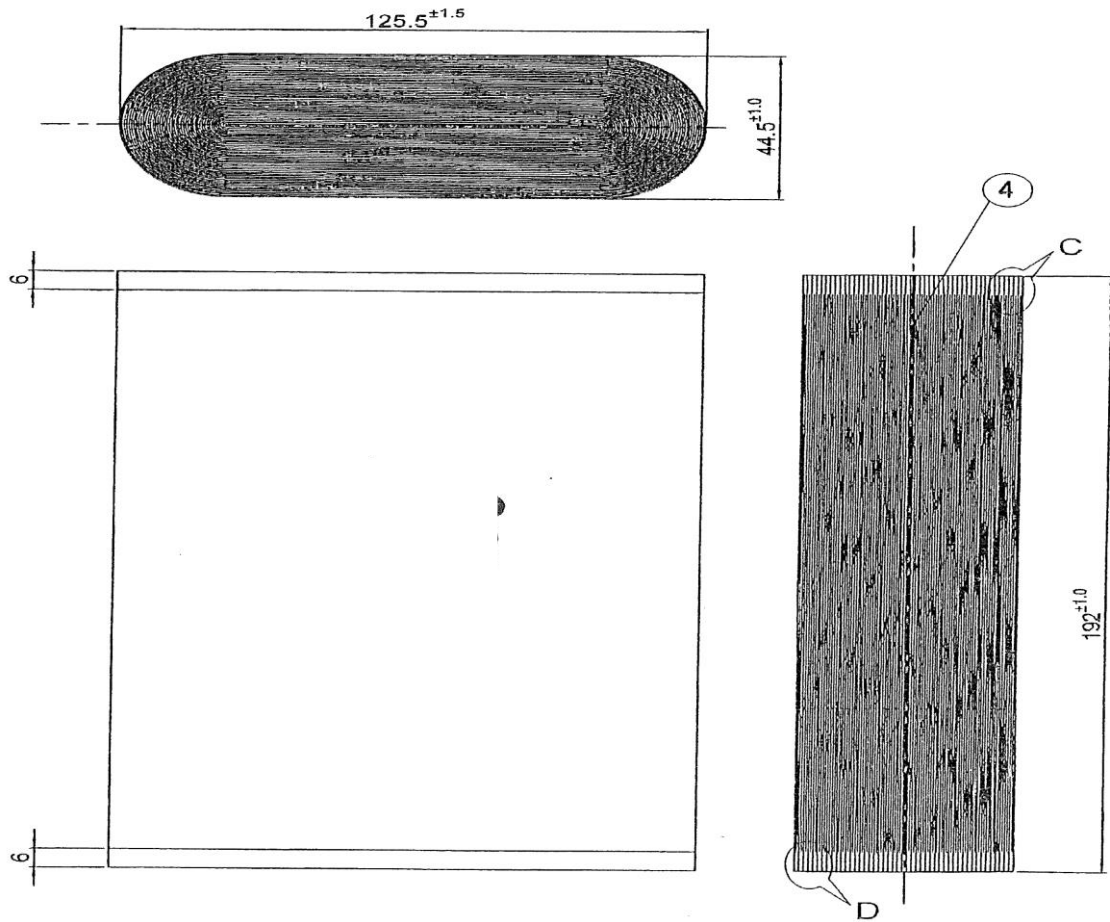



**PURCHASE SPECIFICATION  
FOR LI-ION ELECTRODE WINDING  
MACHINES**

PS-251-607

REV. 01

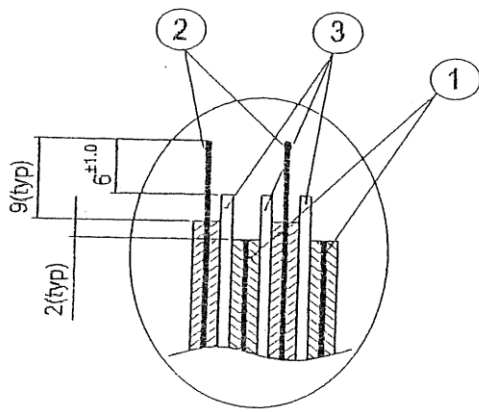

DETAIL-C

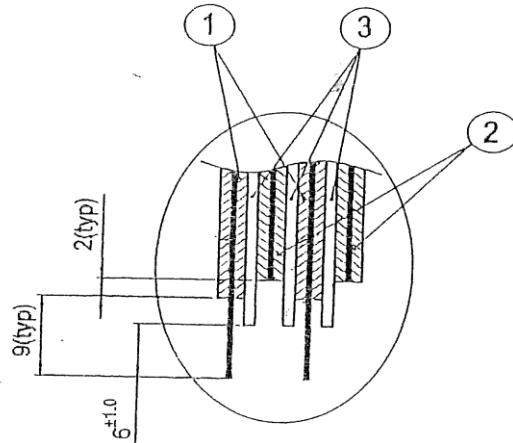

DETAIL-D

1. Positive electrode
2. Negative electrode
3. Separator

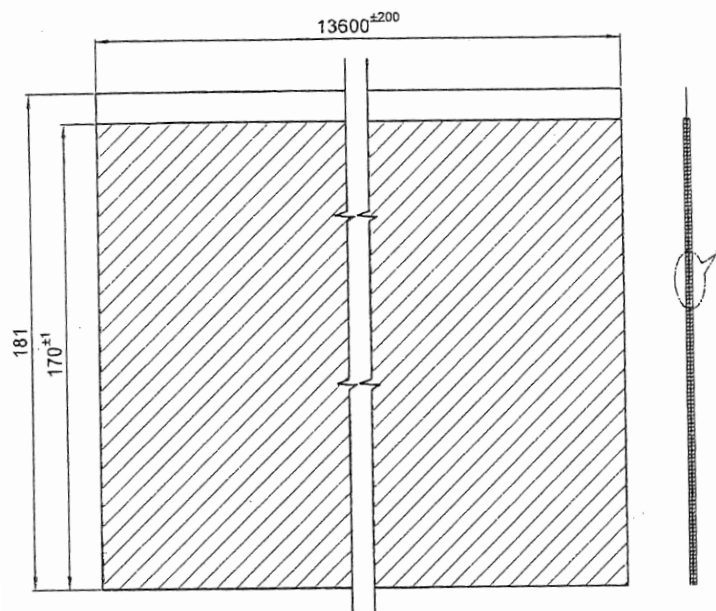

Lithium Metal oxide thickness -160 Micron



**PURCHASE SPECIFICATION  
FOR LI-ION ELECTRODE WINDING  
MACHINES**

PS-251-607

REV. 01

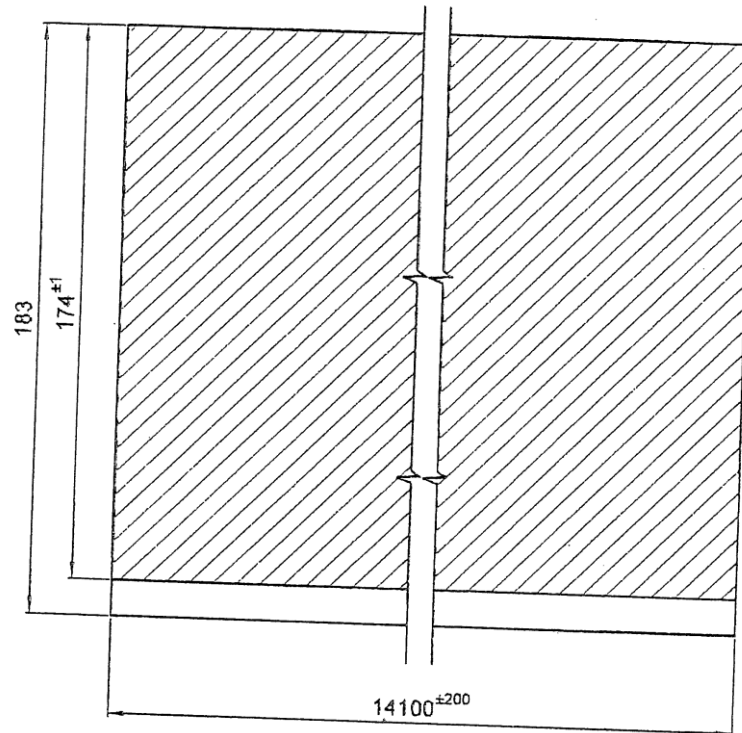

Graphite thickness -160 Micron

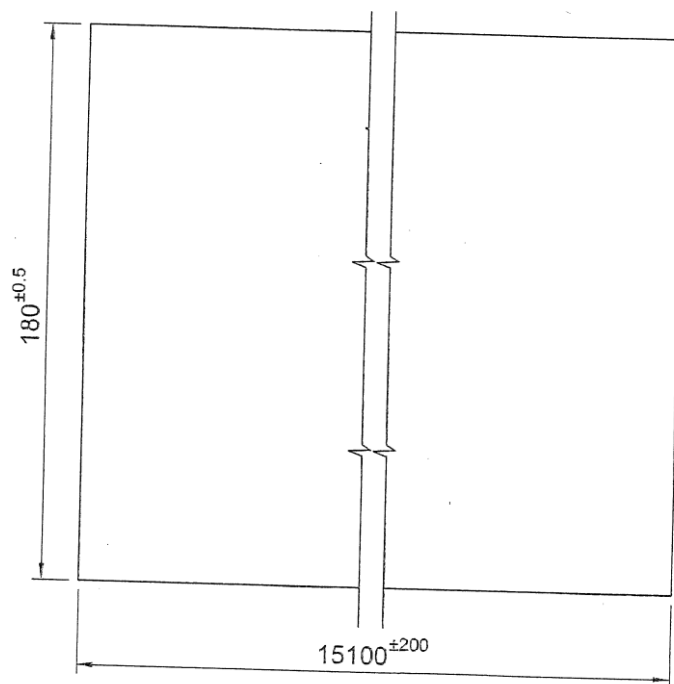

PP/PE/PP thickness -20 Micron



**PURCHASE SPECIFICATION  
FOR LI-ION ELECTRODE WINDING  
MACHINES**

PS-251-607

REV. 01

**Cylindrical Type-1**

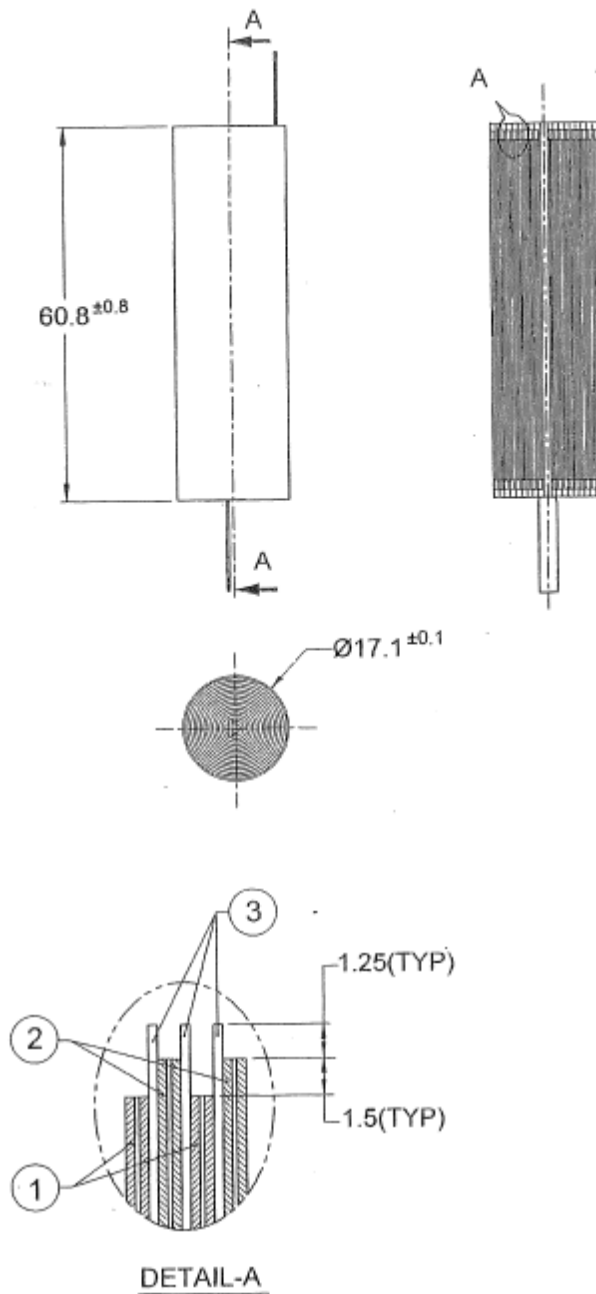

## **Bharat Heavy Electricals Ltd.,**

(A Government of India undertaking)

### **Electronics Division**

PB No.2606, Mysore Road, Bangalore-560026, India

### **General Terms & Conditions for Supply of CAPITAL ITEMS**

**(Imported & Indigenous)**

**Doc Ref: CAPITAL-2017 (scheme)**

#### **I. Enquiry / Request For Quotation (RFQ):**

- (a) Any Purchase Order resulting from this enquiry shall be governed by **these general terms and conditions listed below and special terms and conditions, if any, along with this enquiry** of Bharat Heavy Electricals Limited, Electronics Division, Bangalore-560026 (**hereinafter referred to as BHEL EDN**).
- (b) Any of the terms and conditions not acceptable to vendor, shall be explicitly mentioned in the quotation. Otherwise, it will be treated as that all terms and conditions of this enquiry are acceptable.
- (c) If counter terms and conditions are offered by vendor, BHEL EDN shall not be governed by such terms and conditions, unless it is agreed and incorporated in the Purchase Order of BHEL EDN.
- (d) Any deviation to the terms and conditions not mentioned in the quotation by vendor in response to this enquiry will not be considered, if put forth subsequently or after issue of order, unless clarification is sought for by BHEL EDN and agreed upon in the Purchase Order of BHEL EDN.
- (e) BHEL EDN reserves the right to adopt Reverse Auction for the enquiry sent, at its discretion.
- (f) BHEL EDN shall be at liberty to cancel the tender at any time, before ordering, without assigning any reason.
- (g) Any specific terms and conditions to be complied will be mentioned in RFQ.

#### **II. General Terms and conditions:**

1. **TWO PARTS BID:** Quotation shall be submitted in two parts bid i.e.

##### **(a) Techno-commercial i.e., Un-priced Bid (in one sealed envelope):**

Techno-commercial bid shall be submitted with complete description of the equipment, specification compliances to the enquired specification and all the commercial terms & conditions indicated in the **COMMERCIAL TERMS (ANNEXURE-A / ANNEXURE-B)**. Any other enclosure, which the vendor wishes to submit like product catalogue, technical literature etc., may also be submitted in a sealed envelope super scribed clearly as **“TECHNO-COMMERCIAL BID” with RFQ No. and DUE DATE**. An un-priced copy of price bid (without price) shall also be enclosed with the techno-commercial bid for evaluation of commercial terms. **The vendor shall not give the price in the technical bid. EMD Payment if applicable as mentioned in RFQ shall be enclosed along with the Techno-commercial Bid.**

Confirmation to BHEL specifications shall be indicated by the vendor in the respective columns provided in the purchase specification wherever applicable. Deviations to the specification / item description, if any shall be brought out clearly indicating "DEVIATION TO BHEL SPECIFICATION" without fail as a part of technical offer.

**Compliance to Pre-qualification criteria (if applicable) shall also be enclosed with the Techno-commercial bid.**

Manufacturer's name, their trade mark and brand, part number, alternate material to the one asked in enquiry, if any, should be mentioned in quotation and illustrative leaflets giving technical particulars etc. are to be attached to facilitate consideration and technical evaluation of the quotation.

BHEL EDN material code number (as in enquiry) shall be indicated for each item quoted.

**(b) Price Bid (in one sealed envelope):**

Price bid should contain basic unit prices, discount if any, applicable taxes & duties, packing & forwarding charges (if applicable), Freight & insurances (if applicable) FOB charge (if applicable) etc., in a sealed envelope super scribed clearly as "**PRICE BID**" with **RFQ No. and DUE DATE**. Installation, commissioning, start-up and training charges (if any) shall also be indicated in the price bid.

It is preferred to indicate the rates in both figures and words. In such case, if there is difference / discrepancy between the rates in figures and words, the **least of the two** rates will be considered.

**(c) Tender Offer (above two envelopes inside another sealed envelope):**

Both these sealed envelopes [(a) Techno-commercial i.e., un-priced Bid and (b) Price Bids] shall be kept in a single sealed envelope and super scribed clearly with **RFQ No. and DUE DATE**.

- The above sealed envelope (Tender) shall reach our office on or before the due date by 13:00 hrs. Quotations are to be dropped in the tender box marked for the OPENING ON respective days i.e., MONDAY / WEDNESDAY/ FRIDAY kept at BHEL-ESD's Reception area of our works with caption "Tender box". Quotations also can be dispatched by Couriers / Registered post / FAX / e-mail to the Purchase Executive indicated in the RFQ at the risk of vendor / bidder.**

Quotation through courier / register post / fax / email when addressed to the specific fax number and email address given in the enquiry, to be sent well in advance to enable BHEL EDN purchase personnel to drop in the tender box before the scheduled opening date and time. **Vendor is fully responsible for lack of secrecy on information of such quotations.** Vendor shall confirm with the concerned purchase executive after sending the offer regarding such delivery mode to ensure participation. BHEL EDN is not responsible for any delay in receipt of quotation sent by vendor through post/fax/email.

Late Tenders i.e., Tenders received after due date and time will be rejected.



3. The rate quoted against each item shall be in units stated in the enquiry. Where quotation is in terms of unit other than that in enquiry, relationship between the two units must be furnished in the quotation.
4. As far as possible, the quotations shall be free from corrections / overwriting. Corrections / overwriting, if any should be signed by authorized person with the company seal. Any typographical errors, totaling mistakes, currency mistakes, multiplication mistakes, summary mistakes observed in your priced bids, BHEL may consider whichever is beneficial to BHEL for evaluation. Vendor shall doubly ensure that the quote is correct and complete. The corrections / overwriting if any shall be signed with the seal.
5. Quotations are to be duly signed. Unsigned bids/offers are liable for rejection.
6. Tenders will be opened at **13:30 hrs.** and the venue is Tender opening room near reception in our works. All the tenderers or their authorized representatives (with authorization letter from their principals) may witness opening of techno-commercial bid on the due date.
7. After evaluation of techno-commercial bids, price bids of only those which are technically & commercially accepted, will be opened on a subsequent date, which will be intimated to the concerned in advance for witnessing of price bid opening.
8. The quantity in each item to be purchased may vary from quantity enquired according to the actual requirement at the time of placing the purchase order. Quantity discount, if any, should be mentioned in the quotation.
9. **Bidders should mention GSTIN number of the place of supply and HSN (Harmonised system of nomenclature) / SAC (Services accounting code) number in the offer. In case both supply and service are involved, GSTN number of place of supply for services shall also be mention separately in the offer. Bidders should indicate clearly taxes (SGST/CGST/IGST/UGST) as applicable. In the absence of clarity of these, any claim at a later date will not be entertained. Any changes in Taxes and duties after award of the contract will not be considered except such are those, which are imposed by Govt., notification within the contractual delivery after placement of PO.**
10. **EARNEST MONEY DEPOSIT (EMD):**  
EMD if applicable is mandatory and will be indicated in the RFQ. EMD shall be sent either by Pay Order or Demand Draft in favour of M/s Bharat Heavy Electricals Ltd, Electronics Division, Bangalore only. In case of foreign bidders, e-payment may also be made as EMD, details shall be obtained from purchase executive  
EMD by the Tenderer will be forfeited as per Tender Documents if, the bidder/vendor refuses to honour the Order after award of the same on him and/or withdraws his bid and /or unilaterally changes the offer and/or any of its terms & conditions within the validity period. EMD of unsuccessful Tenderers shall be returned on acceptance of award /LOI/PO on successful Tenderer. The EMD of successful bidder shall be returned only after submission of Contract Execution Bank Guarantee (CEBG).  
EMD will not carry any interest.  
EMD will be waived in the following cases on submission of required documents by:
  - a) Central / State - PSUs / Government departments
  - b) Valid Micro and Small Enterprises under MSME. If claiming exemption under Micro or Small enterprise, submit the notarized/attested copy of your certificate along-with the original auditor's certificate stating the investment in your plant and machinery as on 31.03.2017 as per the format in Annexure-I

**11. DUN & BRADSTREET REPORT (for Foreign purchase):**

In case of foreign vendors, BHEL reserves the right to verify the Dun & Bradstreet report during techno-commercial scrutiny. Please mention your DUNS Number in the techno-commercial bid.

**12. Payment of Agency Commission to Indian Agent (for Foreign purchase):**

i. BHEL shall deal directly with foreign vendors, wherever required, for procurement of goods. However, if the foreign principal desires to avail of the services of an Indian agent, then the foreign principal should ensure compliance to regulatory guidelines - which require mandatory submission of an Agency Agreement.

ii. It shall be incumbent on the Indian agent and the foreign principal to adhere to the relevant guidelines of Government of India, issued from time to time.

iii. The Agency Agreement should specify the precise relationship between the foreign OEM / foreign principal and their Indian agent and their mutual interest in the business. All services to be rendered by agent/ associate, whether of general nature or in relation to the particular contract, must be clearly stated by the foreign supplier/ Indian agent. Any payment, which the agent or associate receives in India or abroad from the OEM, whether as commission or as a general retainer fee should be brought on record in the Agreement and be made explicit in order to ensure compliance to laws of the country.

iv. Any agency commission to be paid by BHEL to the Indian agent shall be in Indian currency only.

v. Tax deduction at source is applicable to the agency commission paid to the Indian agent as per the prevailing rules.

vi. In the absence of any agency agreement, BHEL shall not deal with any Indian agent (authorized representatives / associate / consultant, or by whatever name called) and shall deal directly with the foreign principal only for all correspondence and business purposes.

vii. The "Guidelines for Indian Agents of Foreign Suppliers" enclosed at annexure –'A' shall apply in all such cases.

viii. The supply and execution of the Purchase Order (including indigenous supplies/ service) shall be in the scope of the OEM/ foreign principal. The OEM/ foreign principal should submit their offer inclusive of all indigenous supplies/ services and evaluation will be based on 'total cost to BHEL'. In case OEM/ foreign principal recommends placement of order(s) towards indigenous portion of supplies/ services on Indian supplier(s)/ agent on their behalf, the credentials/ capacity/ capability of the Indian supplier(s)/ agent to make the supplies/ services shall be checked by BHEL as per the extant guidelines of Supplier Evaluation, Approval & Review Procedure (SEARP), before opening of price bids. In this regard, details may be checked as per Annexure-H. It will be the responsibility of the OEM/ foreign principal to get acquainted with the evaluation requirements of Indian supplier/ agent as per SEARP available on [www.bhel.com](http://www.bhel.com).

The responsibility for successful execution of the contract (including indigenous supplies/ services) lies with the OEM/ foreign principal. All bank guarantees to this effect shall be in the scope of the OEM/ foreign principal.

**13. VALUE FOR ERECTION & COMMISSIONING AT BHEL:**

Erection & Commissioning (E&C) value will include services to be rendered at BHEL like erection, commissioning, job proving, performance tests, and training to operators etc.

The estimated percentage of E&C value shall be 10% or as specified in the RFQ.

**E&C value should be quoted separately by bidders.** Only in case where quoted value is less than the value (in %) specified in the NIT or separate E&C values are not mentioned in the offer, value for E&C portion shall be deemed to be considered as the value indicated in NIT & accordingly supply value will be adjusted from that quoted value and balance will be released as E&C payment as per clause 16.

**14. TOTAL COST TO BHEL:**

The bidders shall quote charges for „Supply” and „Erection & Commissioning” separately. Purchase order will be placed on the lowest quotation (L1) only among the technically & commercially accepted quotations. Lowest quotation (L1) is determined on the basis of the total cost to BHEL.

The evaluation of tender shall be on the basis of total cost to BHEL including supply and Erection and Commissioning. For evaluation Exchange rate (TT selling rate of SBI) ruling on the date of Tender opening (Techno-commercial / un-priced Bid) will be considered for converting foreign currency to Indian currency. Loading factors for deviations to BHEL commercial terms & conditions will be considered.

**15. FIRM PRICE:** Rates quoted should be firm from the date of P.O., to the completion of supply and no enhancement in the rates and changes in the techno-commercial terms will be allowed once the quotation is accepted and order is placed.

If Erection & Commissioning is in vendor's scope, then the price shall remain FIRM till commissioning & handing over of the complete system.

**16. TERMS OF PAYMENT:****(a) FOR FOREIGN PURCHASE:**

Payment will be made against “**SIGHT DRAFT**” on presentation of documents to our bankers. Subject to loading factors as per **Clause 32 (Ai)**, BHEL may agree for the payment through LC at its discretion. For LC payment bank charges within India will be borne by BHEL and outside India will be to vendor's account.

The payment terms are as follows:

- (i) 80% against complete dispatch documents i.e. AWB / BOL, Invoice, Packing list, Warranty certificate, Nil shortage certificate, Certificate of country of origin etc. Balance 20% of supply value plus 100% of E&C value will be paid against E&C certificate issued by BHEL and submission of Performance bank guarantee (PBG) valid for 30 days beyond the warranty period by supplier from any of the Consortium Banks of BHEL for 10% of total PO Value in the prescribed format. The PBG confirmation charges shall be borne by vendor.

Note: If PBG could not be submitted, vendors can also accept for the final 10% payment, payable after the warranty period + 3 months of claim period against supplementary invoice subject to the completion of commissioning (if applicable). In such cases loading for PBG is not applicable.

If payment terms as mentioned by BHEL are not agreed by bidder, such bidder have to submit Bank Guarantee at the time of payment / opening of LC in the prescribed Format of the amount, exceeding 80% of the PO value, valid till issue of E&C Certificate for the equipment.

**Payment through L/C:**

Where the payments are through L/C (L/C opening charges are to be loaded), payment of Supply value shall be 80% on dispatch and 20% on issue of E&C Certificate. Payment of E&C value shall be made against E&C certificate issued by BHEL. E&C certificate shall be issued on satisfactory completion of erection, commissioning, job proving, performance tests, and training to operators etc. as envisaged in PO. The L/C shall be opened by BHEL as per following:

- (i) Within 30 Days of receipt of acceptable CEBG, an irrevocable unconfirmed L/C will be opened for 30% of the payment towards supply, due on shipment i.e. 24% of the Supply value of PO (30% of 80%).

Not earlier than 60 days before the shipment date, the value of this irrevocable unconfirmed L/C would be enhanced from 24 % to 80% of the Supply value of PO.

The above L/C can be negotiated after the Shipment against submission of B/L or AWB and such other documents as mentioned in the PO. The above L/C will be valid for a period extending 21 days beyond the shipment date for negotiation of documents.

- (ii) 15 days prior to the scheduled & confirmed arrival of the technicians of supplier with their names, an irrevocable unconfirmed L/C will be opened for a value equal to 20% of the Supply value of PO plus 100% of the E&C value of PO. The validity of L/C would be sufficient to cover the period required for the completion of E&C plus 21 days as negotiation period.

This L/C can be negotiated after: (a) Completion of E&C of the equipment in BHEL and against E&C certificate issued by BHEL and (b) Submission of Performance Bank Guarantee (PBG) by Supplier in the prescribed Format valid for 30 days beyond the warranty period, from one of the Consortium Banks of BHEL or from a reputed Bank and confirmed by Consortium Bank of BHEL for 10% of total PO Value. The PBG confirmation charges shall be borne by vendor.

Under all circumstances, CEBG will be kept valid till the PBG becomes operational.

**(b) FOR INDIGENOUS PURCHASE:**

- (i) 80% basic payment plus 100% taxes, duties and freight charges with 45 days credit from the date of receipt of material at BHEL. Balance 20% of Supply value plus 100% of the E&C portion of PO value will be paid against E&C certificate issued by BHEL and submission of Performance Bank Guarantee (PBG) valid for 30 days beyond the warranty period by Supplier from any of the Consortium Banks of BHEL for 10% of total PO Value in the prescribed Format. The PBG confirmation charges shall be borne by vendor.

Note: If PBG could not be submitted, vendors can also accept for the final 10% payment, payable after the warranty period + 3 months of claim period against supplementary invoice subject to the completion of commissioning (if applicable). In such cases loading for PBG is not applicable.

If payment terms as mentioned by BHEL are not agreed by bidder, such bidder have to submit Bank Guarantee at the time of payment in the prescribed Format of the amount, exceeding 80% of the PO value, valid till issue of E&C Certificate for the equipment.

**17. ADVANCE PAYMENT:** Quotations with “**Advance payment**” shall be liable for rejection.

**18. PENALTY:** Failure to supply/completion of E&C within the delivery time as per purchase order will make the vendor liable to an unconditional **penalty of 0.5 % (half percent) per week at the basic price of the goods/E&C for the undelivered quantity, subject to a maximum of 10%.**

If pre-shipment inspection is involved, date of issue of pre-shipment call by the vendor along with test certificates / test reports / certificate of conformance / calibration reports as proof of completion will be treated as date of dispatch for the purpose of penalty calculation. In the absence of reports stated above, actual date of inspection will be considered as date of dispatch for penalty calculation.

Date of receipt / Date of dispatch / Date of LR / Date of Airway bill / Date of pre-shipment inspection call with relevant documents as stated above, whichever is applicable as mentioned in PO shall be considered for determination of actual delivery date for the purpose of penalty calculation. BHEL is not liable for delayed OA for opening LC or corrections/amendment to LC asked after opening of LC.

**19. Contract Execution Bank Guarantee (CEBG):**

**CEBG shall be required for all POs where value (Supply + E&C) of each P.O. is more than Rs. 20 lakhs. CEBG should be submitted as per the format in Annexure-C.**

The successful vendor shall have to furnish a Contract Execution Bank Guarantee (CEBG) for **10%** of the Total PO value in the prescribed format within 30 days from the date of P.O. but before L/C opening. CEBG shall be from one of the Consortium Banks of BHEL or from a reputed Bank and confirmed by any Consortium Bank of BHEL. All bank charges on account of issuance and confirmation of CEBG whether incurred in India or outside India will have to be borne by the vendor.

CEBG shall be kept valid until 30 days after the date of E&C Certificate, which will be issued on completion of Erection & Commissioning of equipment which includes erection, commissioning, job proving, performance tests, and training to operators etc. as prescribed in PO.

If the supplier fails to submit the CEBG even within 60 days from the date of PO, BHEL reserves the right to cancel PO & forfeit the EMD given by the supplier. In addition, in such case, action will be initiated in line with extant guidelines for Suspension of Business dealings with Suppliers.

**20. PBG:** Performance Bank Guarantee (PBG) (If applicable): The vendor shall submit a PBG worth 10% of basic equipment value in the form and substance acceptable to BHEL from any of the Banks indicated in **ANNEXURE-E**. Such PBG shall be as per the format provided at **ANNEXURE - C/ ANNEXURE - D** and drawn on a non-judicial stamp paper of value Rs.100/-.

PBG shall be valid for 30 days beyond the warranty period of 12 months from the date of commissioning or 18 months from the date of dispatch whichever is earlier or as mentioned in the RFQ. The PBG shall also have 3 months claim period from the date of expiry of such validity of bank guarantee.

**The Bank Guarantee shall be submitted directly to the concerned Purchase Executive by the issuing Bank with their forwarding letter.** BHEL will verify independently with the bank to establish the authenticity.

**21. WARRANTY:** Goods dispatched shall have warranty period of 30 months from the date of dispatch or 24 months from the date of commissioning whichever is earlier or as mentioned in the RFQ.

**22. TERMS OF DELIVERY:**

**(a) FOR IMPORTED PURCHASE:**

Price offered shall be for goods packed and delivered F.C.A (named international Airport) ,FOB International sea port including packing, forwarding, Handling, Ancillary charges like processing of Sight Draft, Letter of credit (L/C) if applicable, negotiation of bank documents, Export declaration, Certificate of origin etc.

Packing shall be Road / Rail / Air / Sea worthy, best suitable for transshipment and to take care of transit damages. If containerized, no. of containers & size of container shall be mentioned. Packing weight (gross & nett) Packing dimensions shall be given prior to shipment to ascertain whether the consignment can be carried on standard cargo in contract or as ODC.

Wooden packing material for all the foreign consignments should be treated as per ISPM-15 & Fumigation / Phytosanitary certificate to be submitted to the freight forwarders/ BHEL along with the invoice, AWB, packing list etc.

Vendors shall indicate the name of International Airport/ Seaport. The consignment shall be handed over to BHEL approved freight forwarded as mentioned in PO.

Note: Name of International Airport has to be selected from any one of the airports indicated in the table provided in ANNEXURE –F.

**(b) FOR INDIGENOUS PURCHASE:**

Equipment shall be delivered on Ex-EDN/ Ex-ESD BHEL, Bangalore basis, inclusive of freight, packing, insurance & forwarding charges.

Packing shall be Road / Rail / Air / Sea worthy, best suitable for transshipment and to take care of transit damages.

Smaller consignments can be dispatched through Courier services/ RPP with the prior approval of the purchasing Executive.

**23. DELIVERY REQUIREMENT:** The bidders should quote their earliest schedule for Supply and E&C against the schedule indicated in the RFQ. BHEL, however, reserves the right to accept an offer not meeting the RFQ schedule.

In the quotation, earliest firm delivery (number of days or weeks) by which material will be dispatched from the date of Purchase order must be indicated. It is recommended to avoid Quotations with delivery term such as `ex-stock`, `subject to prior sale`, or `delivery at the earliest`. Date of BHEL PO is the reference for all purposes.

**24. VALIDITY:** Quotation should remain valid for a period of **90 days** from the date of technical bid opening. Offer with Non-conformance is liable for rejection.

**25. POST-ORDER REQUISITES:**

(a) Vendor shall give an Order Acknowledgement indicating the delivery date within one week of receipt of PO.

(b) Pre-shipment inspection at vendor's works, if required, will be carried out by BHEL. Required assistance will have to be provided by the vendor at the time of pre-shipment inspection.

(c) Test certificates, Calibration certificates and warranty certificates as stipulated at the time of ordering shall be furnished.

(d) Items shall be dispatched by Air/Road/Rail/Sea worthy packing. Any damage and later rejection, due to poor / improper packing shall be to vendor's account.

(e) Any damage/rejection should be made good or replaced immediately without any extra cost to BHEL such as freight, duties, taxes etc. The liability is restricted to the value of the order.

(f) Wherever commissioning is involved, it shall be carried out by the vendor's qualified engineers. Scope of work includes installation, commissioning and start-up trials till satisfactory performance level is reached as certified by BHEL.

(g) BHEL will not be responsible for any loss, damage or injuries to vendor's personnel sustained during installation / commissioning / start-up trials. Vendor shall ensure compliance with all statutory requisites as laid down by local bodies, state & Central Government. Vendor shall indemnify BHEL for all damages/ losses to various personnel during their presence in BHEL's premises for whatever purpose. The following shall be ensured by the vendor:

a) Vendor/contractor shall ensure that the vendor/contractor's workmen always follow safe work procedure during erecting/ commissioning activities.

b) Vendor/contractor shall ensure that the vendor/contractor's workmen wear safety PPEs (shoes, helmets, safety belt etc.) while on erecting/ commissioning work and similar works.

c) Vendor/contractor shall ensure adequate supervision of the activity by his/her supervisor/engineer during the erecting/ commissioning activities.

d) Vendor/contractor shall ensure that vendor/contractor's workmen meet legal requirement such as ESI/Workmen Compensation Act/Accident/medical insurance etc.

e) Vendor/contractor shall take work permit before commencement of the non-routine works of this nature.

f) Undertaking that vendor/contractor will adhere to necessary legal/safety requirements and BHEL shall be kept indemnified against any untoward events taking place during the course of work.

(h) Suitable markings & damage control indicating devices shall be provided where applicable.

26. Equipment shall comply with the standard requirements of ISO 14001 & OHSAS 18001.

27. **RISK PURCHASE:** The purchaser at his discretion may also make purchase of the materials **NOT** supplied in time at the **RISK & COST** of the supplier. In this event, it will be obligatory on the part of the supplier who fails to supply the goods in time to make good to BHEL any loss due to such risk purchase

28. **GENERAL TERMS AND CONDITIONS GOVERNING REVERSE AUCTION (RA):**

(a) Against this enquiry for the subject item/system with detailed scope of supply as per enquiry specifications, BHEL may resort to "REVERSE AUCTION PROCEDURE" i.e., ON LINE BIDDING ON INTERNET. • For the proposed RA, technically and commercially acceptable bidders only shall be eligible to participate.

(b) In case of RA, BHEL will engage the services of a service provider for conduct of the RA who will provide all necessary training and assistance to the bidders before commencement of on line bidding on internet.

(c) Business rules governing the RA will be communicated to the bidders through service provider for compliance.

(d) Vendors have to fax the Compliance form in the prescribed format (provided by Service provider) before start of RA. Without the compliance, the vendor will not be eligible to participate in the event.

(e) BHEL will provide a sample calculation sheet (in EXCEL format) which would help the bidders to arrive at "Net Cash outflow to BHEL" considering various price / cost elements like Packing & forwarding charges, GST for supply, GST for services, Freight charges, Insurance, and loading factors (for non-compliance to BHEL standard Commercial terms & conditions) etc. for each of the bidders to enable them to arrive at "Net Cash outflow to BHEL ( Total Cost to BHEL)" which is the amount the bidder would be bidding during the RA.

(f) RA will be conducted on scheduled date & time and at the end of event, the lowest bidder value will be known on the network.

(g) The lowest bidder has to Fax the duly signed "Price Break-up" in prescribed format as provided on case-to-case basis to BHEL through Service provider within 24 hours of Auction without fail.

(h) Any variation between the on-line bid value and the signed document will be considered as sabotaging the tender process and will invite disqualification of vendor to conduct further business with BHEL, as per the prevailing procedure.



**29. REGRET LETTER:** In case any vendor is unable to quote, vendor shall send a regret letter without fail. In case of non-receipt of quotations or regret letters for three consecutive enquiries, such vendor is liable to be removed from our vendor list.

**30.** Any dispute arising out of this, shall be referred to the sole arbitration of Head of Dept. Materials Management of group concerned, BHEL EDN or any other officer nominated by him and his award shall be final and binding on the parties. The venue of the arbitration in all cases shall be Bangalore.

**31.** Any legal suit in respect of this enquiry lies in the court of Jurisdiction of Bangalore (India) only.

**32. LOADING FACTORS:**

Loading factors as detailed below will be added to the quoted price (basic) to evaluate the lowest quote for non compliance of BHEL standard commercial terms.

**A: Bank Guarantee and Loading against non-acceptance of BHEL's Payment Terms:**

If payments terms as mentioned by BHEL are not agreed by bidder, such bidder have to submit Bank Guarantee at the time of payment / opening of LC in the prescribed Format of the amount, exceeding 80% of the PO value, valid till issue of E&C Certificate for the equipment. However, in no case, payment against dispatch shall exceed 90% of the PO Value.

Additionally, for any deviation sought including as mentioned above, in Payment Terms by bidder w.r.t. tender conditions, following loading shall be followed:

- (a) 10% for the amount & period of relaxation sought by bidder.
- (b) On account of payment through LC, if insisted by bidder, Bank charges shall also be loaded for the deviation in (i) opening of LC by BHEL and (ii) period and amount of LC w.r.t. NIT norms, as per the prevailing bank rates.

**(i). For non compliance of standard Terms of payment (For Foreign Purchase Orders)**

Sl. No.	BHEL standard term	If you quote	Loading factor in % for non-compliance
1	80% against "SIGHT DRAFT" + 20% of supply value and 100% of E&C portion after commissioning and submission of performance bank guarantee.	Payment through Letter of Credit (LC) at sight with bank charges to respective accounts	10%
		Payment through Letter of Credit (LC) with usance credit of 45 days, with bank charges to respective accounts	5%
		Sight draft with credit period less than 45 days.	5%

**A(ii).For non compliance of standard Terms of payment (For Indigenous Purchase Orders)**

Sl. No.	BHEL standard term	If you quote	Loading factor in % for non-compliance
1	80% basic payment plus 100% taxes, duties and freight charges with 45 days credit from the date of receipt of material at BHEL. Balance 20% of supply value plus 100% of E&C portion against E&C certificate issued by BHEL and submission of performance bank guarantee by vendor	Payment through bank, Delivery of material on production of consignee copy of LR.	15%
		Payment through Bank with consignment door deliver to BHEL(without consignee copy of LR)and 45 days credit	2%
		Credit period less than 45 days but not less than 15 days	10%
		80% Payment against proforma invoice on receipt of material at BHEL.	15%
		100% with 45 days credit after commissioning & submission of PBG	Nil

**B. For non compliance of Penalty clause for in 'SUPPLY' and 'E&C':**

For the purpose of penalty for delay E&C of the equipment the duration will be reckoned from the date of intimation by BHEL to vendor for readiness of site

Penalty on delay in „Supply" and/or „E&C" will be applicable to the delays attributed to vendor. Penalty will be considered separately for „Supply" and „E&C".

The rate of penalty for delayed Supply shall be @ 0.5% per week of delay of total PO value (Supply + E&C) in supply subject to a maximum of 10% of total PO value (Supply + E&C).

The rate of penalty for delayed E&C shall be @ 0.5% per week of delay of total PO value (Supply + E&C) in E&C subject to a maximum of 10% of total PO value (Supply + E&C).

Maximum penalty for delay in Supply and E&C together shall be limited to 15% of total PO value (Supply + E&C).

In case PO includes more than one machine, the penalty shall be @ 0.5% per week of delay on total PO value (Supply + E&C) for the delayed machine.

In case any bidder is not accepting the above penalty for delayed Supply and/or E&C, the offer of bidder shall be loaded to the extent to which it is not agreed by the bidder.

Sl. No.	BHEL standard term	If you quote	Loading factor for non-compliance
1	The rate of penalty for delayed Supply shall be @ 0.5% per week of delay of total PO value (Supply + E&C) in supply subject to a maximum of 10% of total PO value (Supply + E&C).	Not agreed.	10%
		Other than the above.	10% - (minus) agreed max. %
2	The rate of penalty for delayed E&C shall be @ 0.5% per week of delay of total PO value (Supply + E&C) in E&C subject to a maximum of 10% of total PO value (Supply + E&C).	Not agreed.	10%
		Other than the above.	10% - (minus) agreed max. %

*In case, any shortage is noticed viz-a-viz PO requirement in the main equipment / spares, such shortages shall be replenished by supplier on FOR destination basis without any cost implication to BHEL i.e. Custom Duty and freight charges etc. up to destination for such short supplies shall be borne by the supplier.*

*Supply period indicated by bidder should include reasonable time required for approval of drawings and other inputs from BHEL. In the Techno-Commercial Bid, the bidder shall submit milestones for various activities in co-relation with Supply and E&C period quoted by him.*

**C. For non compliance of Performance Bank Guarantee (PBG) (If applicable):**

Sl. No.	BHEL standard term	If you quote	Loading factor for non-compliance
1	PBG for 10% of the basic material cost shall be furnished in the BHEL prescribed format.	Not agreed.	10 %
		Other than the above.	10% - (minus) agreed max. %

**D. For non conformance to delivery requirement indicated in the RFQ:**

Sl. No.	BHEL standard term	If you quote	Loading factor for non-compliance
1	Delivery requirement as indicated in the RFQ in number of weeks from the date of issue of PO	Not agreed for the stipulated delivery in the RFQ	0.5 % per week up to max., of 10% for the difference in delivery period

**E. For non compliance of Warranty:**

Sl. No.	BHEL standard term	If you quote	Loading factor for non-compliance
1	30 months from the date of dispatch or 24 months from the date of commissioning whichever is earlier or as indicated in the RFQ	Not agreed.	6%
		Less than 12 months or as indicated in the RFQ	0.5 % per month for the difference in period

**F (i) For Non- agreement on delivery at BHEL-EDN/ESD (For Foreign Purchase Orders):**

Sl. No.	BHEL standard term	If you quote	Loading factor for non-compliance
1	FCA / FOB to nearest international Airport/Seaport	Not agreed for the standard term of delivery	10 %

**F(ii) For Non- agreement on delivery at BHEL-EDN/ESD (For Indigenous Purchase Orders):**

Sl. No.	BHEL standard term	If you quote	Loading factor for non-compliance
1	Ex- EDN or ESD / BHEL, Bangalore (Free delivery to BHEL Bangalore including freight, packing & forwarding charges)	Not agreed for the standard term of delivery	10 %



**ANNEXURE-A**

**COMMERCIAL TERMS (to be enclosed with TECHNO-COMMERCIAL BID)**  
**(for Foreign Purchase Orders)**

Sl. No.	Particulars	Bidder's confirmation
1	<b>Price basis:</b> Firm i.e., from the date of PO to completion of supply [Price Variation Clause (PVC) not acceptable]	Acceptable / Not acceptable
2	EMD as mentioned in RFQ	Submitted/Not submitted
3	CEBG as detailed in clause 19	Acceptable / Not acceptable
4	<b>Terms of Payment:</b> Against "SIGHT DRAFT" on presentation of documents to our bankers. (a)80 % is payable on negotiation of complete set of original documents. Balance 20% of supply value plus 100% of E&C portion will be paid after commissioning and submission of performance bank guarantee by vendor.  (b) Deviation if any please specify	(a) Acceptable / Not acceptable  (b)
5	<b>BHEL's penalty clause:</b> (a) Delay in delivery as per PO delivery date will result in penalty of penalty of 0.5 % (half percent) per week at the basic price of the goods/E&C for the undelivered quantity, subject to a maximum of 10% individually. (b) Deviation if any Please specify	(a) Acceptable / Not acceptable  (b)
.6	<b>Performance Bank guarantee (If applicable):</b> PBG for 10% of the basic material cost shall be furnished in the BHEL prescribed format as detailed in clause 20.	Yes / No
7	<b>Terms of delivery:</b> (a) FCA/FOB interntional Airport/Seaport as per Clause 22 (a)(Indicate name of International Airport/Seaport) (b) Deviation if any Please specify	(a)Acceptable / Not acceptable  (b)
8	<b>Warranty:</b> (a) 30 months from the date of dispatch or 24 months from the date of commissioning or as specified in RFQ (b) Deviation if any Please specify	(a)Acceptable / Not acceptable  (b)
9	<b>Delivery period:</b> Number of weeks from date of BHEL PO. E & C: Number of weeks from date of supply at BHEL.	_____ Weeks ----- Weeks
	<b>Validity:</b> (a) Quotation should remain valid for a period of 90 days from the due date (b) Deviation if any Please specify	(a) Acceptable / Not acceptable  (b)
11	<b>Bank charges(If applicable):</b> (a) Bank charges within India is to BHEL account and outside India is to Vendor"s account (b) Deviation if any Please specify	(a) Acceptable / Not acceptable  (b)
12	Weight and Dimension of consignment with packing	Furnished / To be furnished

With this, it is inferred that vendor has understood and accepts all terms & conditions as indicated above.  
NOTE: The above filled-in and signed-sealed document (in original) shall be furnished as part of Part-I Bid without fail. If no deviations are brought, it will be treated as if all terms and conditions of this enquiry are accepted by vendor without any deviation.

Signature of vendor / with stamp

**ANNEXURE-B**

**COMMERCIAL TERMS (to be enclosed with TECHNO-COMMERCIAL BID)**  
**(For Indigenous Purchase Orders)**

Sl.No.	Particulars	Bidder's confirmation
1	<b>Price basis:</b> Firm i.e., from the date of PO to completion of supply [Price Variation Clause (PVC) not acceptable]	Acceptable / Not acceptable
2	EMD as mentioned in RFQ	Submitted/Not submitted
3	CEBG as detailed in clause 19	Acceptable / Not acceptable
4	<b>GST Number of bidder:-</b> <b>HSN code for material supply:-</b>	
5	<b>SGST / CGST / IGST / UGST for material supply</b> If applicable indicate %.	Applicable / Not applicable _____ %
6	<b>SAC code for services:-</b> <b>SGST / CGST / IGST / UGST for services.</b>	-----%
7	<b>Payment terms:</b> (a) 80 % basic payment plus 100% taxes , duties and freight charges with 45 days credit from date of receipt of material. Balance 20% of supply value plus 100% of E&C portion will be paid after commissioning and submission of performance bank guarantee by vendor. (b) Deviation if any please specify	(a) Acceptable / Not acceptable  (b)
8	<b>BHEL's penalty clause:</b> (a) Delay in delivery as per PO delivery date will result in penalty of penalty of 0.5 % (half percent) per week at the basic price of the goods/E&C for the PO quantity, subject to a maximum of 10% individually. (b) Deviation if any Please specify	(a) Acceptable / Not acceptable  (b)
9	<b>Performance Bank guarantee (PBG) (If applicable:</b> PBG for 10% of the basic material cost shall be furnished in the BHEL prescribed format as per clause 20.	Yes / No
10	<b>Terms of delivery:</b> (a) Ex- EDN or ESD / BHEL, Bangalore (Free delivery to BHEL Bangalore including freight, packing & forwarding charges) (b) Deviation if any Please specify	(a) Acceptable / Not acceptable  (b)
11	<b>Warranty:</b> (a) 30 months from the date of dispatch or 24 months from the date of commissioning or as specified in RFQ (b) Deviation if any Please specify	(a) Acceptable / Not acceptable  (b)
12	<b>Delivery period:</b> Number of weeks from date of BHEL PO <b>E &amp; C :</b> Number of weeks from date of supply at BHEL	_____ Weeks _____ Weeks
13	<b>Validity:</b> (a) Quotation should remain valid for a period of 90 days from the due date (b) Deviation if any Please specify	(a) Acceptable / Not acceptable  (b)
14	<b>Bank charges (If applicable):</b> (a) All Bank charges to vendor's account (b) Deviation if any Please specify	(a) Acceptable / Not acceptable  (b)
15	Weight and Dimension of consignment with packing	Furnished / To be furnished

With this, it is inferred that vendor has understood and accepts all terms & conditions as indicated above.  
NOTE: The above filled-in and signed-sealed document (in original) shall be furnished as part of Part-I Bid without fail. If no deviations are brought, it will be treated as if all terms and conditions of this enquiry are accepted by vendor without any deviation.

Signature of vendor / with stamp

ANNEXURE – C**CONTRACT EXECUTION BANK GUARANTEE BOND**

This deed of guarantee made this ..... day of ..... 20... by the..... Bank Ltd, (hereinafter referred to as “the Bank”) in favour of Bharat Heavy Electricals Limited, Bangalore having its registered Office at New Delhi with its Unit Office at Bangalore where as M/s..... having its registered office at ..... (hereafter called the “the Contractor”) have entered in to contract with Bharat Heavy Electricals Limited, Bangalore for the supply of ..... vide Purchase Order No ..... dated .....

1. We ..... Bank Ltd, do hereby undertake to pay to Bharat Heavy Electricals Limited, Bangalore an amount not exceeding Rs..... against any loss or damage caused to or suffered or would be caused to or suffered by Bharat Heavy Electricals Limited, Bangalore by reason of any breach by the said Contractor of any of the terms or conditions contained in the said Purchase Order.

2. We, ..... Bank Ltd, do hereby undertake to pay the amounts due and payable under this guarantee without any demur, merely on a demand from Bharat Heavy Electricals Limited, Bangalore stating that the amount claimed is due by way of loss or damage caused to or would be caused to or suffered by Bharat Heavy Electricals Limited, Bangalore by reason of any breach by the said Contractor of any of the terms or conditions contained in the said Purchase Order or by reason of the Contractor’s failure to perform the said Purchase Order. Any such demand made on the Bank shall be conclusive as regards the amount due and payable by the Bank under this guarantee. However, our liability under this guarantee shall be restricted to an amount not exceeding Rs.....

3. We, ..... Bank Ltd, further agree to the guarantee herein contained shall remain in full force and effect during the period that would be taken for the performance of the said Purchase Order and that it shall continue to be enforceable till all the dues of Bharat Heavy Electricals Limited, Bangalore under or by virtue of the said Purchase Order have been fully paid and its claims satisfied or discharged or till Bharat Heavy Electricals Limited, Bangalore certifies that the terms and conditions of the said Purchase Order have been fully and properly carried out by the said Contractor and accordingly discharges the guarantee. Unless a demand or claim under this guarantee is made on us in writing on or before the ..... we shall be discharged from all liability under this guarantee thereafter. But where such claim or demand has been preferred by the Company with the Bank before the expiry of the said date the claim shall be enforceable and Payable only by any one of the BHEL Consortium Banks in India ( List is attached herewith) notwithstanding the fact that the said enforcement is effected after the said date



For the purpose of this clause, any letter making demand on the Bank by Bharat Heavy Electricals Limited, Bangalore dispatched by Registered Post with Ack. Due or by Telegram or by any Electronic media addressed to the Bank ( **any one of the BHEL Consortium Banks as per list attached as selected by the vendor**) shall be deemed to be the claim / demand in writing referred to above irrespective of the fact as to whether and when the said letter reaches the Bank, as also any letter containing the said demand or claim is lodged with the Bank personally.

4. We,.....Bank Ltd, further agree with Bharat Heavy Electricals Limited, Bangalore that Bharat Heavy Electricals Limited, Bangalore shall have the fullest liberty without our consent and without affecting in any manner our obligations hereunder to vary any of the terms and conditions of the said Purchase Order or to extend time of performance by the said contractor from time to time or to postpone for any time or from time to time any of the powers exercisable by Bharat Heavy Electricals Limited, Bangalore against the said Contractor and to forbear or enforce any of the terms and conditions relating to the said Purchase Order and we shall not be relieved from our liability by reason of any such variation, or extension being granted to the said Contractor or for any forbearance, act or omission on the part of Bharat Heavy Electricals Limited, Bangalore or any indulgence by Bharat Heavy Electricals Limited, Bangalore to the said Contractor or by any such matter of thing whatsoever which under the law relating to sureties would but for this provision have effect of so relieving us.

5. Any claim or dispute arising under the terms of this document shall only be enforced or settled in the Courts at Bangalore.

We, ..... Bank Ltd, lastly undertake not to revoke this guarantee during its currency except with the previous consent of Bharat Heavy Electricals Limited, Bangalore in writing.

In witness whereof we..... (indicate the name of Bank) have hereunto setout Bank

Seal the..... day ..... month 201

**The contact details of the Issuing Bank such as Email ID, Phone No. and Fax No. should be indicated in the CEBG. Also please note that the CEBG should be forwarded to us with the covering letter of the issuing Bank with signature and seal.**

**(1) It should be typed in the Rs. 100 value of stamp paper.**

**(2) It should be signed by TWO bank officials with Rubber stamp containing names & employee numbers of bank officials.**

**(3) It should be submitted with bank covering letter with sign and seal of the bank official.**

Please note that issuance of the CEBG without meeting the above requirement will render the document invalid.

---





ANNEXURE-D

**BANK GUARANTEE FOR PERFORMANCE SECURITY**

Bank Guarantee No:

Date:

To

NAME

& ADDRESSES OF THE BENEFICIARY

Dear Sirs,

In consideration of the Bharat Heavy Electricals Limited<sup>1</sup> (hereinafter referred to as the 'Employer' which expression shall unless repugnant to the context or meaning thereof, include its successors and permitted assignments) incorporated under the Companies Act, 1956 and having its registered office at \_\_\_\_\_ through its Unit at.....(name of the Unit) having awarded to (Name of the Vendor / Contractor / Supplier) having its registered office at \_\_\_\_\_<sup>2</sup> hereinafter referred to as the 'Contractor/Supplier', which expression shall unless repugnant to the context or meaning thereof, include its successors and permitted assigns), a contract Ref No.....dated .....<sup>3</sup> valued at Rs.....<sup>4</sup> ( Rupees )/FC.....(in words.....) for .....<sup>5</sup> (hereinafter called the 'Contract') and the Contractor or having agreed to provide a Contract Performance Guarantee, equivalent to .....% (... Percent) of the said value of the Contract to the Employer for the faithful performance of the Contract,we, ....., (hereinafter referred to as the Bank), having registered/Head office at ..... and inter alia a branch at ..... being the Guarantor under this Guarantee, hereby, irrevocably and unconditionally undertake to forthwith and immediately pay to the Employer a maximum amount Rs ----- ( Rupees -----) without any demur, immediately on a demand from the Employer, .Any such demand made on the Bank shall be conclusive as regards the amount due and payable by the Bank under this guarantee. However, our liability under this guarantee shall be restricted to an amount not exceeding Rs. \_\_\_\_\_.

We undertake to pay to the Employer any money so demanded notwithstanding any dispute or disputes raised by the Contractor/Supplier in any suit or proceeding pending before any Court or Tribunal relating thereto our liability under this present being absolute and unequivocal.



The payment so made by us under this Guarantee shall be a valid discharge of our liability for payment thereunder and the contractors/supplier shall have no claim against us for making such payment.

We the .....bank further agree that the guarantee herein contained shall remain in full force and effect during the period that would be taken for the performance of the said Contract and that it shall continue to be enforceable till all the dues of the Employer under or by virtue of the said Contract have been fully paid and its claims satisfied or discharged.

We ..... BANK further agree with the Employer that the Employer shall have the fullest liberty without our consent and without affecting in any manner our obligations hereunder to vary any of the terms and conditions of the said Contract or to extend time of performance by the said Contractor/Supplier from time to time or to postpone for any time or from time to time any of the powers exercisable by the Employer against the said Contractor/Supplier and to forbear or enforce any of the terms and conditions relating to the said Agreement and we shall not be relieved from our liability by reason of any such variation, or extension being granted to the said Contractor/Supplier or for any forbearance, act or omission on the part of the Employer or any indulgence by the Employer to the said Contractor/Supplier or by any such matter or thing whatsoever which under the law relating to sureties would but for this provision have effect of so relieving us.

The Bank also agrees that the Employer at its option shall be entitled to enforce this Guarantee against the Bank as a principal debtor, in the first instance without proceeding against the Contractor and notwithstanding any security or other guarantee that the Employer may have in relation to the Contractor's liabilities.

This Guarantee shall remain in force upto and including.....<sup>6</sup> and shall be extended from time to time for such period as may be desired by Employer.

This Guarantee shall not be determined or affected by liquidation or winding up, dissolution or change of constitution or insolvency of the Contractor/Supplier but shall in all respects and for all purposes be binding and operative until payment of all money payable to the Employer in terms thereof. Unless a demand or claim under this guarantee is made on us in writing on or before the .....<sup>7</sup> we shall be discharged from all liabilities under this guarantee thereafter. We, ..... BANK lastly undertake not to revoke this guarantee during its currency except with the previous consent of the Employer in writing.

Notwithstanding anything to the contrary contained hereinabove:

- a) The liability of the Bank under this Guarantee shall not exceed.....<sup>8</sup>
- b) This Guarantee shall be valid up to .....<sup>9</sup>
- c) Unless the Bank is served a written claim or demand on or before \_\_\_\_\_<sup>10</sup> all rights under this guarantee shall be forfeited and the Bank shall be relieved and discharged from all liabilities under this guarantee irrespective of whether or not the original bank guarantee is returned to the Bank.



We, \_\_\_\_\_ Bank, have power to issue this Guarantee under law and the undersigned as a duly authorized person has full powers to sign this Guarantee on behalf of the Bank.

For and on behalf of  
(Name of the Bank)

Dated.....

Place of Issue.....

<sup>1</sup> NAME AND ADDRESS OF EMPLOYER I.e Bharat Heavy Electricals Limited

<sup>2</sup> NAME AND ADDRESS OF THE VENDOR /CONTRACTOR / SUPPLIER.

<sup>3</sup> DETAILS ABOUT THE NOTICE OF AWARD/CONTRACT REFERENCE

<sup>4</sup> PROJECT/SUPPLY DETAILS

<sup>5</sup> BG AMOUNT IN FIGURES AND WORDS

<sup>6</sup> VALIDITY DATE

<sup>7</sup> DATE OF EXPIRY OF CLAIM PERIOD

<sup>8</sup> BG AMOUNT IN FIGURES AND WORDS.

<sup>9</sup> VALIDITY DATE

<sup>10</sup> DATE OF EXPIRY OF CLAIM PERIOD

Note:

1. Units are advised that expiry of claim period may be kept 2/3 months after validity date.
2. In Case of Bank Guarantees submitted by Foreign Vendors -
  - a. From Nationalized/Public Sector / Private Sector/ Foreign Banks (BG issued by Branches in India) can be accepted subject to the condition that the Bank Guarantee should be enforceable in the town/city or at nearest branch where the Unit is located i.e. Demand can be presented at the Branch located in the town/city or at nearest branch where the Unit is located.
  - b. From Foreign Banks (wherein Foreign Vendors intend to provide BG from local branch of the Vendor **country's Bank**)
  - b.1 In such cases, in the Tender Enquiry/ Contract itself, it may be clearly specified that Bank Guarantee issued by any of the Consortium Banks only will be accepted by BHEL. As such, Foreign Vendor needs to make necessary arrangements for issuance of Counter - Guarantee by Foreign Bank in favour of the Indian Bank (BHEL's Consortium Bank). It is advisable that all charges for issuance of Bank Guarantee/ counter- Guarantee should be borne by the Foreign Vendor. The tender stipulation should clearly specify these requirements.



- b.2 In case, Foreign Vendors intend to provide BG from Overseas Branch of our Consortium Bank (e.g. if a BG is to be issued by SBI Frankfurt), the same is acceptable . However, the procedure at sl.no. b.1 will required to be followed.
- b.3 The BG issued may preferably be subject to Uniform Rules for Demand Guarantees (URDG) 758 (as amended from time to time). In case, of Foreign Vendors, the BG Format provided to them should clearly specify the same.

The BG should clearly specify that the demand or other document can be presented in

**ANNEXURE – E**

**LIST OF CONSORTIUM BANKS**

BANK GUARANTEE (BG) SHALL BE ISSUED FROM THE FOLLOWING BANKS ONLY:

	Nationalized Banks		Nationalized Banks
1	Allahabad Bank	19	Vijaya Bank
2	Andhra Bank		Public Sector Banks
3	Bank of Baroda	20	IDBI
4	Canara Bank		Foreign Banks
5	Corporation Bank	21	CITI Bank N.A
6	Central Bank	22	Deutsche Bank AG
7	Indian Bank	23	The Hong Kong and Shanghai Banking Corporation Ltd. (HSBC)
8	Indian Overseas Bank	24	Standard Chartered Bank
9	Oriental Bank of Commerce	25	The Royal Bank of Scotland N.V.
10	Punjab National Bank	26	J P Morgan
11	Punjab & Sindh Bank		Private Banks
12	State Bank of India	27	Axis Bank
13	State Bank of Hyderabad	28	The Federal Bank Limited
14	Syndicate Bank	29	HDFC Bank
15	State Bank of Travancore	30	Kotak Mahindra Bank Ltd
16	UCO Bank	31	ICICI Bank
17	Union Bank of India	32	IndusInd Bank
18	United Bank of India	33	Yes Bank

Note:

- BG should be directly sent to BHEL by the issuing Bank along with cover letter.
- All BGs must be issued from BHEL consortium banks listed above.
- BHEL may accept BG from other Public Sector Banks also which are not listed above.
- BG will not be accepted from Scheduled Banks and Co-operative Banks.
- In case BG is issued from a bank located outside Indian Territory and is issued in foreign currency, the BG must be routed through and confirmed by any one of the above mentioned consortium banks.
- This list is subject to changes. Hence vendors are requested to check this list every time before issuing BGs.

**ANNEXURE-F****LIST OF INTERNATIONAL GATEWAY AIRPORTS**

SCHEDULE NO	COUNTRY	CURRENCY CODE	AIRPORT
D01	UK	GBP	LONDON (HEATHROW)
D02	UK	GBP	NEW CASTLE
D03	UK	GBP	OXFORD. CHETLAM
D04	UK	GBP	BRISTOL. WELLINGBOROUGH
D05	UK	GBP	BIRMINGHAM
D06	UK	GBP	EAST MIDLANDS
D07	UK	GBP	MANCHESTER
D08	UK	GBP	LEEDS
D09	UK	GBP	GLASGOW
D10	FRANCE	EURO	PARIS (ROISSY) & LYON
D11	SWEDEN	EURO	STOCKHOLM
D12	SWEDEN	EURO	GOTHENBERG & MALMO
D13	ITALY	EURO	ROMA, MILAN
D14	ITALY	EURO	TURIN, BOLOGNA, FLORENCE
D15	NETHERLANDS	EURO	AMSTERDAM, ROTTERDAM
D16	AUSTRIA	EURO	VIENNA, LINZ, GRAZ
D17	BELGIUM	EURO	ANTWERP, BRUSSELS
D18	DENMARK	DKK	COPENHAGEN
D19	JAPAN	JPY	TOKYO, OSAKA
D20	SINGAPORE	SGD	SINGAPORE
D21	CANADA	CAD	TORONTO
D22	CANADA	CAD	MONTREAL
D23	USA	USD	NEW YORK, BOSTON
D24	USA	USD	CHICAGO
D25	USA	USD	SAN FRANCISCO, LOS ANGELES
D26	USA	USD	ALANTA, HOUSTON
D27	GERMANY	EURO	MUNICH, KOLN, DUSSELDORF, HANNOVER, HAMBURG, STUTTGART, DAMSTADT, MANIHIEM, NURUMBERG
D28	GERMANY	EURO	FRANKFURT



D29	GERMANY	EURO	BERLIN
D30	SWITZERLAND	SFR	BASLE, ZURICH, GENEVA
D31	SPAIN	EURO	BARCELONA
D32	AUSTRALIA	AUD	SYDNEY
D33	AUSTRALIA	AUD	MELBOURNE
D34	AUSTRALIA	AUD	PERTH
D35	CZECH	EURO	PRAGUE
D36	HONG KONG	HKD	HONG KONG
D37	NEW ZELAND	NZD	AUCKLAND
D38	RUSSIA	USD	MOSCOW
D39	SOUTH KOREA	USD	KIMPO INTERNATIONAL, INCHEON
D40	FINLAND	EURO	HELSINKI
D41	ROMANIA	EURO	BUCHAREST
D42	NORWAY	EURO	OSLO
D43	IRELAND	EURO	DUBLIN
D44	ISRAEL	USD	TEL AVIV
D45	UAE	USD	DUBAI
D46	OMAN	USD	MUSCAT
D47	EGYPT	USD	CAIRO
D48	TAIWAN	USD	TAIPEI
D49	UKRAINE	USD	KIEV
D50	CHINA	USD	SHANGHAI, SHENZHEN
D51	PHILIPINES	USD	MANILA
D52	MALAYSIA	USD	KUALALUMPUR, PE NANG
D53	CYPRUS	USD	LARNACA
D54	SOUTH AFRICA	USD	JOHANNESBERG, DURBAN
D55	SLOVAKIA	EURO	BARTISLOVA
D56	SAUDI ARABIA	SAR	RIYADH
D57	TURKEY	EURO	ISTANBUL
D58	THAILAND	USD	BANGKOK
D59	BRAZIL	USD	SAO PAULO, RIO DE JANEIRO



ANNEXURE-G  
Electronic Funds Transfer ( EFT) OR Paylink Direct Credit Form

Please Fill up the form in CAPITAL LETTERS only.

TYPE OF REQUEST(Tick one): \_\_\_\_\_ CREATE \_\_\_\_\_ CHANGE

BHEL Vendor / Supplier Code:	
Company Name :	
Permanent Account Number(PAN):	
Address	

City: _____	PINCODE _____	STATE _____	
-------------	---------------	-------------	--

Contact Person(s)	
Telephone No:	
Fax No:	
e-mail id:	

1	Bank Name:	
2	Bank Address:	
3	Bank Telephone No:	
4	Bank Account No:	
5	Account Type: Savings/Cash Credit	
6	9 Digit Code Number of Bank and branch appearing on MICR cheque issued by Bank	
7	Bank swift Code (applicable for EFT only)	
8	Bank IFSC code (applicable for RTGS)	
9	Bank IFSC code (applicable for NEFT)	

- A I hereby certify that the particulars given above are true, correct and complete and that I, as a representative for the above named Company, hereby authorise BHEL, EDN, Bangalore to electronically deposit payments to the designated bank account.
- B If the transaction is delayed or not effected at all for reasons of incomplete or incorrect information, I would not hold BHEL / transferring Bank responsible.
- C This authority remains in full force until BHEL, EDN, Bangalore receives written notification requesting a change or cancellation.
- D I have read the contents of the covering letter and agree to discharge the responsibility expected of me as a participant under ECS / EFT.

Date:

Authorised Signatory:  
Designation:

Telephone NO. with STD Code

Company Seal





Bank Certificate

We certify that \_\_\_\_\_ has an Account No \_\_\_\_\_ with us and we confirm that the bank details given above are correct as per our records.

Date:

(.....) Place:

Signature

Please return completed form along with a blank cancelled cheque or photocopy thereof to: Bharat Heavy Electricals Ltd,

Attn:

Electronics Division, Mysore Road, BANGALORE - 560 026

In case of any Query, please contact : concerned Purchase Executive

**ANNEXURE – H**

This format is applicable only to Indian Suppliers/ Agents supplying indigenous portion of Foreign Purchases.

<b>SEARP (SRF) Clause No</b>	<b>Detail</b>
	<b>Name &amp; address of the firm</b>
<b>1.0</b>	<b>Products/ Systems / Services being considered for</b>
<b>2.0</b>	<b>General Information</b>
2.2	Name of Chief Executive
2.3	Details of authorized signatory
<b>3.0</b>	<b>Ownership Information</b>
3.1	Type of firm
3.2	Nature of Business <ul style="list-style-type: none"> <li>• Attach <b>authorization letter</b> and <b>agency agreement</b> from Principal ( from whom capital equipment is procured)</li> <li>• Attach copy of declaration from Foreign Principal for <b>total guarantee/ warranty of indigenous supplies</b></li> </ul>
3.3	Year of establishment
3.4	Year of commencement of business
<b>4.0</b>	<b>Registration particulars</b>
4.1	Permanent Account No.
4.2 / 4.3	Sales Tax / TIN no
4.6	Service tax no. (in case of E&C)
<b>5.0</b>	<b>Organisational strength</b>
<b>6.0</b>	<b>Other particulars</b>
6.1	If the company is already registered with other units
6.2	Directors/ Partners, if related to any BHEL Employee
6.9	If any Ex BHEL Personnel employed by the Company
6.12	Details of pending legal issues with BHEL
6.13	Bank Account information
<b>9.0</b>	<b>Financial information</b>
9.6	Sales/ Turnover details of last 3 years (or from the date of incorporation whichever is less )



## ANNEXURE I

### BENEFITS FOR MSE SUPPLIERS AS PER MSMED ACT 2006 AND PUBLIC PROCUREMENT POLICY 2012

MSE suppliers can avail the intended benefits only if they submit along with the offer, attested copies of either EM II certificate having deemed validity (five years from the date of issue of acknowledgement in EM II) or valid NSIC certificate or EM II certificate along with attested copy of CA certificate (Format enclosed at page 2 where deemed validity of EM II certificate of five years has expired) applicable for the relevant financial year (latest audited). Date to be reckoned for determining the deemed validity will be the date of bid opening (Part 1 in case of two part bid). Non submission of such documents will lead to consideration of their bid at par with other bidders. No benefit shall be applicable for this enquiry if any deficiency in the above required documents are not submitted before price bid opening. If the tender is to be submitted through e-procurement portal, then the above required documents are to be uploaded on the portal. Documents should be notarized or attested by a Gazetted officer.



Certificate by Chartered Accountant on Letter Head

This is to certify that M/s .....  
.....(Hereinafter referred to as 'y') having its registered  
office at ..... is registered under MSMED Act 2006, (Entrepreneur Memorandum No ((Part-II)  
.....dtd .....Category: ..... (Micro/Small). (Copy enclosed).

Further verified from the Books of Accounts that the investment of the company as per the latest audited  
financial year ..... as per MSMED Act 2006 is as follows:

1. For Manufacturing Enterprises: Investment in plant and machinery ( i.e., original cost excluding land and building and  
the items specified by the Ministry of Small Industries vide its notification No.S.O.1722 (E) dated October 5, 2006:  
Rs. ....Lacs.
2. For Service Enterprises: Investment in equipment (original cost excluding land and building and furniture, fittings  
and other items not directly related to the service rendered or as may be notified under the MSMED Act, 2006:  
Rs. ....Lacs.

The above investment of Rs. ....Lacs in within permissible limit of Rs.....Lacs  
or.....Micro/ Small (Strike off which is not applicable) Category under MSMED Act 2006.

(or)

The company has been graduated from its original category (Micro/ Small) (Strike off which is not applicable) and the  
date of graduation of such enterprise from its original category is .....(dd/mm/yy) which is within the period of 3  
years from the date of graduation of such enterprise from its original category as notified vide S.O.No.3322(E) dated  
01.11.2013 published in the gazette notification dated 04.11.2013 by Ministry of MSME.

Date: (Signature)

Name -

Membership Number -

Seal of Chartered Accountant

**PRICED BID for Design , Supply,I&C of Winding Machine for Li-Ion Cell manufacturing facility at BHEL - ESD**

**Price bid - ANK0000162**

Sl. No.	Description	Quantity (set)	Currency	Unit Price	Total Price	Remarks
1	KA9018209255 Winding Machine	1				
2	Installation and Commissioning of KA9018209255 Winding Machine	1				
3	AMC for 3 years for KA9018209255 Winding Machine (excluding spares as mentioned in S. no. B)	1		-		
4	GST for KA9018209255 Winding Machine (if applicable indicating %)	1				
5	GST for Installation and Commissioning of KA9018209255 Winding Machine (if applicable indicating %)	1				
6	GST AMC for 3 years for KA9018209255 Winding Machine(if applicable indicating %)	1				
<b>A</b>	Total cost including equipment, I&C, AMC and applicable taxes for KA9018209255 Winding Machine (in figures)	1				
	Total cost including equipment, I&C, AMC and applicable taxes for KA9018209255 Winding Machine (in words)					
<b>B</b>	Price of Spares required during post warranty 3 year AMC period (list of spares to be enclosed along with technical bid)	1				
	GST for spares for KA9018209255 Winding Machine (if applicable indicating %)	1				

## DETAILS OF COMPANY PERFORMANCE

## A. Capacity Details:

Manufacturing Capacity (Major machines with Qty.)	Type of Major Machines	Qty.
Machines supplied during last 5 years (Year-wise with Qty.)	Scheduled Supply Period	Actual Supply Period
Outstanding Order Book position (Type of Machine with Qty. & name of customers*)		
Liquidation Plan of all machines including BHEL machines under consideration for ordering		

\* If any bidder is unable to give name of ALL the customer(s) due to confidentiality restrictions, they may give details without disclosing such customer's identity.

## B. Performance of supplies to BHEL:

Details of POs to be considered in last 5 years shall include (i) Last 5 POs fully executed and (ii) all POs overdue for supply and/or E&C. Details of all machines in the POs to be given.

Sl. No.	Name of M/c with broad specs.	Name of BHEL Unit	P.O. No. & Date	P.O. Value	Supply Date		Erection & Commissioning		Reason of delay, if any
					As per P.O.	Actual/ Likely	E&C period incl. job prove out as agreed (in days)	Actual / Likely period of E&C completion (in days)	
(1)	(2)	(3)	(4)	(5)	(6)	(7)	(8)	(9)	(10)
1.									
2.									
3.									
4.									

Note: 1. In case bidder has not received any Purchase Order in the last 5 years from any of the Units of BHEL, then 'NIL' should be indicated.

2. Reasons for delay to be explained in details.

3. BHEL reserves the right to reject the offer, if past performance of the bidder is evaluated to be unsatisfactory and/or false information is given by the bidder.

# **INTEGRITY PACT**

## **Between**

Bharat Heavy Electricals Ltd. (BHEL), a company registered under the Companies Act 1956 and having its registered office at “BHEL House”, Siri Fort, New Delhi – 110049 (India) hereinafter referred to as “The Principal”, which expression unless repugnant to the context or meaning hereof shall include its successors or assigns of the ONE PART

## **and**

\_\_\_\_\_, (description of the party along with address), hereinafter referred to as “The Bidder/ Contractor” which expression unless repugnant to the context or meaning hereof shall include its successors or assigns of the OTHER PART

## **Preamble**

The Principal intends to award, under laid-down organizational procedures, contract/s for

\_\_\_\_\_  
\_\_\_\_\_

\_\_\_\_\_. The Principal values full compliance with all relevant laws of the land, rules and regulations, and the principles of economic use of resources, and of fairness and transparency in its relations with its Bidder(s)/ Contractor(s).

In order to achieve these goals, the Principal will appoint Independent External Monitor(s), who will monitor the tender process and the execution of the contract for compliance with the principles mentioned above.

## **Section 1 – Commitments of the Principal**

- 1.1 The Principal commits itself to take all measures necessary to prevent corruption and to observe the following principles:-
  - 1.1.1 No employee of the Principal, personally or through family members, will in connection with the tender for, or the execution of a contract, demand, take a promise for or accept, for self or third person, any material or immaterial benefit which the person is not legally entitled to.
  - 1.1.2 The Principal will, during the tender process treat all Bidder(s) with equity and reason. The Principal will in particular, before and during the tender process, provide to all Bidder(s) the same information and will not provide to any Bidder(s) confidential / additional information through which the Bidder(s) could obtain an advantage in relation to the tender process or the contract execution.
  - 1.1.3 The Principal will exclude from the process all known prejudiced persons.
- 1.2 If the Principal obtains information on the conduct of any of its employees which is a penal offence under the Indian Penal Code 1860 and Prevention of Corruption Act 1988 or any other statutory penal enactment, or if there be a substantive suspicion in this regard, the Principal will inform its Vigilance Office and in addition can initiate disciplinary actions.

## **Section 2 – Commitments of the Bidder(s)/ Contractor(s)**

- 2.1 The Bidder(s)/ Contractor(s) commit himself to take all measures necessary to prevent corruption. He commits himself to observe the following principles during his participation in the tender process and during the contract execution.
  - 2.1.1 The Bidder(s)/ Contractor(s) will not, directly or through any other person or firm, offer, promise or give to the Principal or to any of the Principal's employees involved in the tender process or the execution of the contract or to any third person any material, immaterial or any other benefit which he / she is not legally entitled to, in



order to obtain in exchange any advantage of any kind whatsoever during the tender process or during the execution of the contract.

2.1.2 The Bidder(s)/ Contractor(s) will not enter with other Bidder(s) into any illegal or undisclosed agreement or understanding, whether formal or informal. This applies in particular to prices, specifications, certifications, subsidiary contracts, submission or non-submission of bids or any other actions to restrict competitiveness or to introduce cartelization in the bidding process.

2.1.3 The Bidder(s)/ Contractor(s) will not commit any penal offence under the relevant IPC/ PC Act; further the Bidder(s)/ Contractor(s) will not use improperly, for purposes of competition or personal gain, or pass on to others, any information or document provided by the Principal as part of the business relationship, regarding plans, technical proposals and business details, including information contained or transmitted electronically.

2.1.4 The Bidder(s)/ Contractor(s) will, when presenting his bid, disclose any and all payments he has made, and is committed to or intends to make to agents, brokers or any other intermediaries in connection with the award of the contract.

2.2 The Bidder(s)/ Contractor(s) will not instigate third persons to commit offences outlined above or be an accessory to such offences.

### **Section 3 – Disqualification from tender process and exclusion from future contracts**

If the Bidder(s)/ Contractor(s), before award or during execution has committed a transgression through a violation of Section 2 above, or acts in any other manner such as to put his reliability or credibility in question, the Principal is entitled to disqualify the Bidders(s)/ Contractor(s) from the tender process or take action as per the separate “Guidelines for Suspension of Business Dealings with Suppliers/ Contractors” framed by the Principal.

## **Section 4 – Compensation for Damages**

- 4.1 If the Principal has disqualified the Bidder(s) from the tender process prior to the award according to Section 3, the Principal is entitled to demand and recover the damages equivalent to Earnest Money Deposit/ Bid Security.
- 4.2 If the Principal has terminated the contract according to Section 3, or if the Principal is entitled to terminate the contract according to section 3, the Principal shall be entitled to demand and recover from the Contractor liquidated damages equivalent to 5% of the contract value or the amount equivalent to Security Deposit/Performance Bank Guarantee, whichever is higher.

## **Section 5 – Previous Transgression**

- 5.1 The Bidder declares that no previous transgressions occurred in the last 3 years with any other company in any country conforming to the anti-corruption approach or with any other Public Sector Enterprise in India that could justify his exclusion from the tender process.
- 5.2 If the Bidder makes incorrect statement on this subject, he can be disqualified from the tender process or the contract, if already awarded, can be terminated for such reason.

## **Section 6 – Equal treatment of all Bidders/ Contractors/ Sub-contractors**

- 6.1 The Bidder(s)/ Contractor(s) undertake(s) to demand from his sub-contractors a commitment consistent with this Integrity Pact. This commitment shall be taken only from those sub-contractors whose contract value is more than 20% of Bidder's/ Contractor's contract value with the Principal.
- 6.2 The Principal will enter into agreements with identical conditions as this one with all Bidders and Contractors.
- 6.3 The Principal will disqualify from the tender process all bidders who do not sign this pact or violate its provisions.

## **Section 7 – Criminal Charges against violating Bidders/ Contractors /Sub-contractors**

If the Principal obtains knowledge of conduct of a Bidder, Contractor or Subcontractor, or of an employee or a representative or an associate of a Bidder, Contractor or Subcontractor which constitutes corruption, or if the Principal has substantive suspicion in this regard, the Principal will inform the Vigilance Office.

## **Section 8 –Independent External Monitor(s)**

- 8.1 The Principal appoints competent and credible Independent External Monitor for this Pact. The task of the Monitor is to review independently and objectively, whether and to what extent the parties comply with the obligations under this agreement.
- 8.2 The Monitor is not subject to instructions by the representatives of the parties and performs his functions neutrally and independently. He reports to the CMD, BHEL.
- 8.3 The Bidder(s)/ Contractor(s) accepts that the Monitor has the right to access without restriction to all contract documentation of the Principal including that provided by the Bidder(s)/ Contractor(s). The Bidder(s)/ Contractor(s) will grant the monitor, upon his request and demonstration of a valid interest, unrestricted and unconditional access to his contract documentation. The same is applicable to Sub-contractor(s). The Monitor is under contractual obligation to treat the information and documents of the Bidder(s)/ Contractor(s) / Sub-contractor(s) with confidentiality.
- 8.4 The Principal will provide to the Monitor sufficient information about all meetings among the parties related to the contract provided such meetings could have an impact on the contractual relations between the Principal and the Contractor. The parties offer to the Monitor the option to participate in such meetings.
- 8.5 As soon as the Monitor notices, or believes to notice, a violation of this agreement, he will so inform the Management of the Principal and request the Management to discontinue or

take corrective action, or heal the situation, or to take other relevant action. The Monitor can in this regard submit non-binding recommendations. Beyond this, the Monitor has no right to demand from the parties that they act in a specific manner, refrain from action or tolerate action.

8.6 The Monitor will submit a written report to the CMD, BHEL within 8 to 10 weeks from the date of reference or intimation to him by the Principal and, should the occasion arise, submit proposals for correcting problematic situations.

8.7 The CMD, BHEL shall decide the compensation to be paid to the Monitor and its terms and conditions.

8.8 If the Monitor has reported to the CMD, BHEL, a substantiated suspicion of an offence under relevant IPC / PC Act, and the CMD, BHEL has not, within reasonable time, taken visible action to proceed against such offence or reported it to the Vigilance Office, the Monitor may also transmit this information directly to the Central Vigilance Commissioner, Government of India.

8.9 The number of Independent External Monitor(s) shall be decided by the CMD, BHEL.

8.10 The word 'Monitor' would include both singular and plural.

## **Section 9 – Pact Duration**

9.1 This Pact begins when both parties have legally signed it. It expires for the Contractor 12 months after the last payment under the respective contract and for all other Bidders 6 months after the contract has been awarded.

9.2 If any claim is made / lodged during this time, the same shall be binding and continue to be valid despite the lapse of this pact as specified as above, unless it is discharged/ determined by the CMD, BHEL.

**Section 10 – Other Provisions**

- 10.1 This agreement is subject to Indian Laws and jurisdiction shall be registered office of the Principal, i.e. New Delhi.
- 10.2 Changes and supplements as well as termination notices need to be made in writing. Side agreements have not been made.
- 10.3 If the Contractor is a partnership or a consortium, this agreement must be signed by all partners or consortium members.
- 10.4 Should one or several provisions of this agreement turn out to be invalid, the remainder of this agreement remains valid. In this case, the parties will strive to come to an agreement to their original intentions.
- 10.5 Only those bidders/ contractors who have entered into this agreement with the Principal would be competent to participate in the bidding. In other words, entering into this agreement would be a preliminary qualification.

-----  
For & On behalf of the Principal  
(Office Seal)

-----  
For & On behalf of the Bidder/ Contractor  
(Office Seal)

Place-----

Date-----

Witness: \_\_\_\_\_  
(Name & Address) \_\_\_\_\_  
\_\_\_\_\_

Witness: \_\_\_\_\_  
(Name & Address) \_\_\_\_\_  
\_\_\_\_\_